



CATALOGUE
MAY 2024

DIHR
we mean clean



INDEX

UNDER-COUNTER DISHWASHERS		
CS	Robust and essential glass & dishwashers	4
GS	Glass & dishwashers with double-wall door	12
DS	Double skin glass & dishwashers	20
ELECTRON	High-tech double skin glass & dishwashers	28
OPTIMA	Connected glass and dishwashers with clean water technology	38
HOOD-TYPE DISHWASHERS		
HT 10	Robust and essential hood-type dishwashers	48
HT 11	Single skin hood-type dishwashers	56
HT 11 I	Insulated hood-type dishwashers	64
HT 12 ELECTRON	Latest generation hood-type dishwashers	72
HT 14 OPTIMA	Connected hood-type dishwashers with clean water technology	82
STOCK & WASH DISHWASHERS		
TWIN STAR	Stock & Wash dishwashers	92
RACK-TYPE DISHWASHERS		
RX COMPACT	Compact rack-type dishwashers with simple rinse	100
RX EVO	Rack-type dishwashers with single or double rinse	108
RX PRO	Rack-type dishwashers with reinforced double rinse	124
RX OPTIMA	Rack-type dishwashers with 3R+ reinforced triple rinse	136
FLIGHT-TYPE DISHWASHERS		
 QX PRO	Flight-type dishwashers with reinforced double rinse	148
 QX OPTIMA	Flight-type dishwashers with 3R+ reinforced triple rinse	164
TUNNEL TRAY WASHER & TRANSPORTATION SYSTEMS		
TX	Tunnel traywasher with dryer	180
TS	Transportation systems	184
WAREWASHERS		
LP	Warewashers	186
GRANULES WAREWASHER		
GRANULES	Granules warewashers	198
PULL-THROUGH CRATE WASHERS		
VX - VX PRO	Pull-through crate washers	204
CONVEYOR CRATE WASHERS		
LX - LX-HD	Conveyor crate washers	214
BASKETS	Standard supplied baskets	226
SALES CONDITIONS	General sales conditions	227

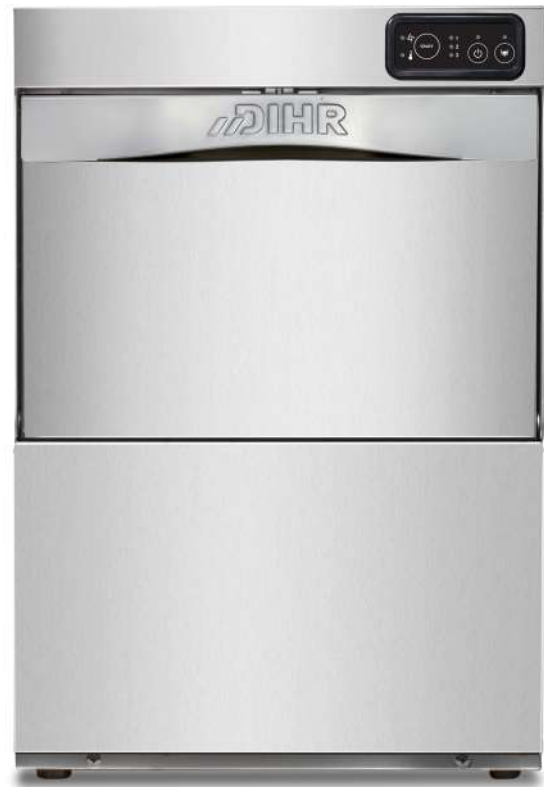

You asked and we listened! We are thrilled to announce our brand new range: CS. These robust and essential glass and dishwashers simply make sense. Nothing superfluous: solid S/S body with

double wall-door, sloped tank, innovative and light arms, controlled temperatures and, only if needed, detergent dispenser and drain pump. Wash, rinse, restart. It is really that simple.











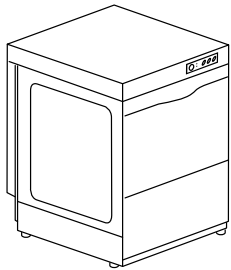



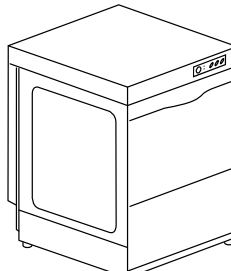



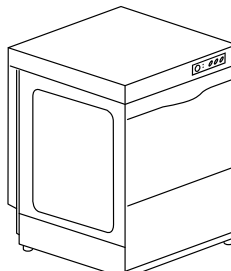





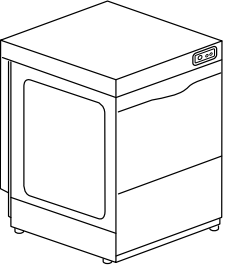

ELECTRONIC VERSION

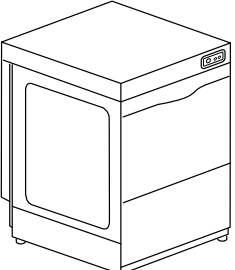
The intuitive LED control panel of the CS L models will display if the correct temperatures of both tank and boiler have been reached. You can choose among 3 different wash programs to perfectly tailor the performances of the machine to the crockery that needs to be cleaned.

FEATURES

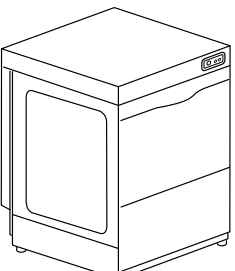
- Solid structure in AISI 304 stainless steel
- Sound and heat proof double-skin door
- Door with anti-shock system
- Sloped tank with screwed basket rails
- Overflow and drain pipes integrated system, for a triple protection of the washing pump
- Non-drip roof to safeguard the hygiene of the freshly washed dishes
- 1 wash cycle on electromechanical versions
- 3 wash cycles on electronic versions
- Innovative system of coupled wash and rinse arms in polypropylene and fiber of glass (CS 50 / CS 50 L)
- Light wash and rinse arms, granting the best efficiency also when the water pressure is weaker
- Easy to remove nozzles, to help with daily cleaning operations
- Back flow prevention valve
- Thermostop system: the rinse starts only when the water in boiler reaches 85 °C
- Standard rinse-aid dispenser
- Glasswashers also available with round basket (CS 35 / CS 40)
- Self-cleaning cycle on the electronic versions

Model		Voltage	Capacity	Dimensions	Code
CS 35	1 PROGRAM NEW				
	<p>RACK EQUIPMENT</p> <ul style="list-style-type: none"> 2 X 10730 1 X 10728 1 X 15060 	230 V ~ 50 Hz 2,59 kW	 195 H  350x350	400x495x585 H 28 kg	CS 35
CS 40	1 PROGRAM NEW				
	<p>RACK EQUIPMENT</p> <ul style="list-style-type: none"> 2 X C121 1 X 10728 1 X 15060 	230 V ~ 50 Hz 2,59 kW 2,65 kW (LS)	 305 H  Ø 295 (LS)  400x400	450x535x700 H 37 kg	CS 40 CS 40 LS
CS 50	1 PROGRAM NEW				
	<p>RACK EQUIPMENT</p> <ul style="list-style-type: none"> 1 X C40 1 X C44 1 X 15060 	230 V ~ 50 Hz 3,2 kW	 320 H  Ø 345  500x500	590x600x850 H 57 kg	CS 50



Model		Voltage	Capacity	Dimensions	Code
CS 35 L	3 PROGRAMS				
	<p>NEW</p> <p>RACK EQUIPMENT 2 X 10730 1 X 10728 1 X 15060</p> 	230 V ~ 50 Hz 2,59 kW	 195 H	400x495x595 H 28 kg	CS 35 L
			 350x350		
CS 40 L	3 PROGRAMS				
	<p>NEW</p> <p>RACK EQUIPMENT 2 X C121 1 X 10728 1 X 15060</p> 	230 V ~ 50 Hz 2,59 kW 2,65 kW (LS)	 305 H	450x535x710 H 37 kg	CS 40 L
			 Ø 295 (LS)  400x400		
CS 50 L	3 PROGRAMS				
	<p>NEW</p> <p>RACK EQUIPMENT 1 X C40 1 X C44 1 X 15060</p> 	230 V ~ 50 Hz 3,2 kW	 320 H	590x600x850 H 57 kg	CS 50 L
			 Ø 345  500x500		



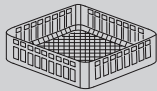
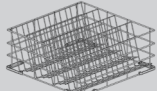
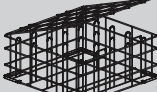

OPTIONS

		PS	DDE	DB	CR	TS
Model	220-240 V 50 Hz	Drain Pump	Detergent Dispenser	Rinse-Aid Dispenser	Round Basket	Thermostop System
CS 35	●	€	€	●	€	●
CS 40	●	€	€	●	€	●
CS 40 LS	●	€	€	●	€	●
CS 50	●	€	€	●	----	●
CS 35 L	●	€	€	●	€	●
CS 40 L	●	€	€	●	€	●
CS 40 LS L	●	€	€	●	€	●
CS 50 L	●	€	€	●	----	●

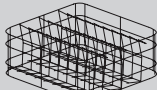
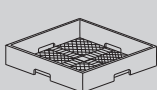
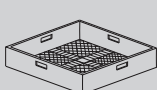
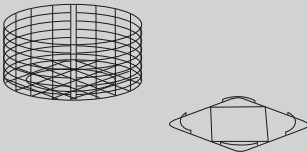
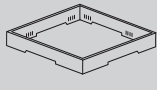
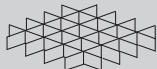
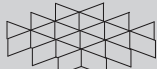
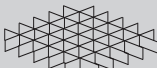
- LS** Upper wash
- L** LED electronic
- Standard
- Not available

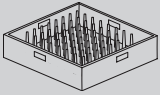
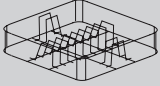
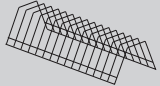
Water supply 55 °C
EAC label upon request

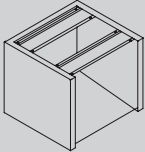
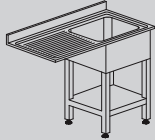
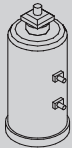
	Description	Capacity	Dimensions	Code
	GLASS BASKET		350x350x110 H 400x400x135 H	10730 C 121
	SLOPED GLASS BASKET	Ø 100 max	500x500x200 H	C 26
	REUSABLE CUP BASKET	5x5 glasses 30 mm < Ø < 90 mm H max 185 mm	500x500x235 H	C 135 
	SLOPED GLASS BASKET	Ø 90 max Ø 120 max	400x400x185 H 400x400x160 H	C 123 C 79
	NARROW MESH CUTLERY BASKET		500x500x106 H	C 41
	LARGE MESH BASKET	For glasses	500x500x105 H	C 44
	ROUND GLASS BASKET	Basket	Ø 350x105 H	C 21
	ROUND BASKET SUPPORT	Support	350x350	C 36
		Basket	Ø 400x145 H	C 16
		Support	400x400	C 38
	HOLDER FOR GLASS SUPPORT	For glass support (C112-C113-C114)	500x500x50 H	C111
	GLASS SUPPORT	5x5 Glass Ø 87 mm (C111)	500x500x50 H	C 112
	GLASS SUPPORT	4x4 Glass Ø 110 mm (C111)	500x500x50 H	C 113
	GLASS SUPPORT	6x6 Glass Ø 72 mm (C111)	500x500x50 H	C 114

	Description	Capacity	Dimensions	Code	
	PLATE BASKET	18 Plates	500x500x105 H	C 40	
	PLATE BASKET	12 Plates	400x400x120 H	C 31	
	SAUCER HOLDER	14 Saucers	300x100x90 H	10728	
	CUTLERY BASKET		Ø 120x120 H	15060	
	STAND	Stainless steel stand	592x535x500 H	999900517	
	SINK UNIT FOR UNDER-COUNTER MODELS	Sink 500x400x300H	1200x700x850 H	A 20	
	WATER SOFTENER	12 l	Ø 200x500 H	D 1	
	AUTOMATIC WATER SOFTENER	12 l (max 800 l)	315x510x685 H	D 2	

* Wooden cage +2% minimum €

Special dimensions for tables upon request

Tables shown in right-to-left version



The glass and dishwashers of the GS series are ideal for bars, pubs, restaurants and hotels. These undercounter machines, with a redesigned control panel, feature a wide loading capacity granting the highest performance at a reasonable price.

According to the user's needs the machine can be customized thanks to many optional features such as water softener, detergent dispenser and drain pump.











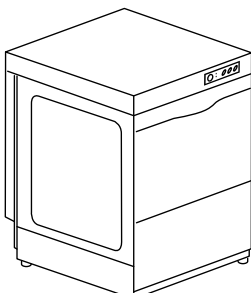

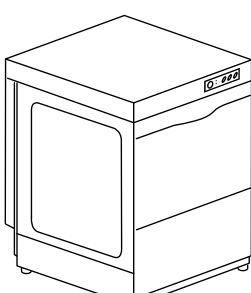



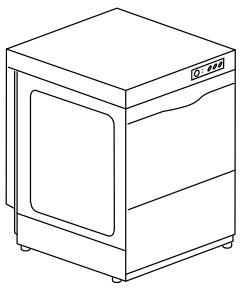



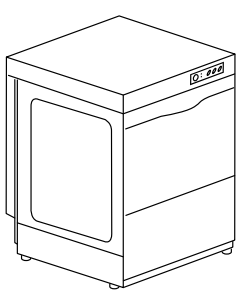



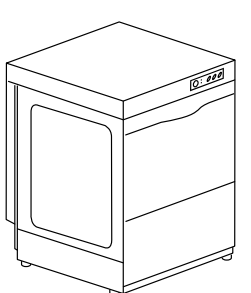





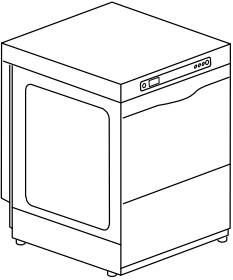

ELECTRONIC VERSION

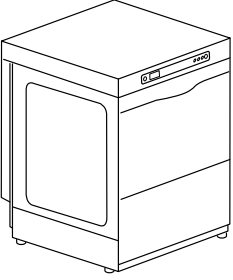
An electronic control panel is available for GS T models. The LED panel displays the temperatures of both tank and boiler, the wash cycle and status and main alarm codes for malfunctions. You can now choose among four different washing programs to perfectly tailor the performances of the machine to the crockery that needs to be cleaned. The soft start function grants extra protection for fragile objects.

FEATURES

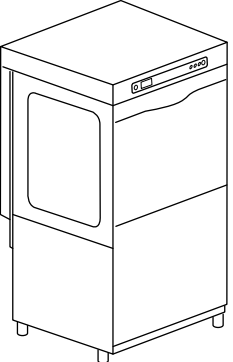
- AISI 304 structure
- Sound and heat proof double-skin door
- Door with anti-shock system
- Deep-drawn and inclined tank for a perfect total drain
- Overflow and drain pipes integrated system, for a triple protection of the wash pump
- Non-drip roof to safeguard the hygiene of the freshly washed dishes
- Light wash and rinse arms, granting the best efficiency also when the water pressure is in weaker
- Easy to remove nozzles, to help with daily cleaning operations
- Back flow prevention valve
- Standard rinse-aid dispenser (peristaltic version on demand)
- Thermostop system: the rinse starts only when the water in boiler reaches 85 °C
- CE certified components
- Electronic version with four preset washing programs
- Automatic regeneration for Touch models with inbuilt water softener
- Glasswashers available also with round basket (GS 35 / GS 37 / GS 40)
- Innovative system of coupled wash and rinse arms in polypropylene and fiber of glass (GS 50 ECO / GS 50 / GS 50 T / GS 85 T)
- Self-cleaning cycle on the TOUCH versions
- Soft Start wash pump on the TOUCH versions
- Additional upper surface filter (on demand only for GS 50 ECO / GS 50 / GS 50 T / GS 85 T)

Model		Voltage	Capacity	Dimensions	Code
GS 35	1 PROGRAM				
	<p>RACK EQUIPMENT</p> <ul style="list-style-type: none"> 2 X 10730 1 X 10728 1 X 15060 	230 V ~ 50 Hz 2,6 kW	 195 H  350x350	400x495x585 H 28 kg	GS 35 GS 35 D
GS 37	1 PROGRAM				
	<p>RACK EQUIPMENT</p> <ul style="list-style-type: none"> 2 X C10 1 X 10728 1 X 15060 	230 V ~ 50 Hz 2,6 kW 2,8 kW (LS)	 275 H  Ø 280 LS  370x370	420x490x650 H 30 kg	GS 37 GS 37 D GS 37 LS GS 37 LS D
GS 40	1 PROGRAM				
	<p>RACK EQUIPMENT</p> <ul style="list-style-type: none"> 2 X C121 1 X 10728 1 X 15060 	230 V ~ 50 Hz 3,2 kW	 305 H  Ø 295 LS  400x400	450x535x700 H 37 kg	GS 40 GS 40 D GS 40 LS GS 40 LS D
GS 50 ECO	15 AMP MONOPHASE - 1 PROGRAM				
	<p>RACK EQUIPMENT</p> <ul style="list-style-type: none"> 1 X C40 1 X C44 1 X 15060 	230 V ~ 50 Hz 3,5 kW	 320 H  Ø 345  500x500	590x600x850 H 57 kg	GS 50 ECO Surface filters
GS 50	2 PROGRAMS				
	<p>RACK EQUIPMENT</p> <ul style="list-style-type: none"> 1 X C40 1 X C44 1 X 15060 	400 V 3N ~ 50 Hz 5,2 kW	 320 H  Ø 345  500x500	590x600x850 H 57 kg	GS 50 GS 50 D Surface filters

Model		Voltage	Capacity	Dimensions	Code
GS 40 T	ELECTRONIC 4 PROGRAMS				
	RACK EQUIPMENT 2 X C121 1 X 10728 1 X 15060 	230 V ~ 50 Hz 3,2 kW	 305 H  Ø 295 LS  400x400	450x535x700 H 37 kg	GS 40 T GS 40 T DA GS 40 T LS GS 40 T LS DA
GS 50 T	ELECTRONIC 4 PROGRAMS				
	RACK EQUIPMENT 1 X C40 1 X C44 1 X 15060 	400 V 3N ~ 50 Hz 5,2 kW	 320 H  Ø 345  500x500	590x600x850 H 57 kg	GS 50 T GS 50 T DA Surface filters
GS 85 T	ELECTRONIC 4 PROGRAMS				
<i>IMPROVED</i> 	RACK EQUIPMENT 1 X C40 1 X C44 1 X 15060 	400 V 3N ~ 50 Hz 6,9 kW	 355 H  Ø 380  500x500	590x600x1290 H 69 kg	GS 85 T GS 85 T DA Surface filters

OPTIONS

Model						XP	PS	DDE	ST	DB
	220-240 V 50 Hz	380-415 V 3N 50 Hz	220-240 V 3 50 Hz	60 Hz	Electronic timer	Extra Power	Drain Pump	Detergent Dispenser	Soft Start	Rinse-Aid Dispenser
GS 35	●	----	----	€	●	----	€	€	----	●
GS 35 D	●	----	----	€	●	----	€	€	----	●
GS 37	●	----	----	€	●	----	€	€	----	●
GS 37 D	●	----	----	€	●	----	€	€	----	●
GS 37 LS	●	----	----	€	●	----	€	€	----	●
GS 37 LS D	●	----	----	€	●	----	€	€	----	●
GS 40	●	□	□	€	●	€	€	€	----	●
GS 40 D	●	□	□	€	●	€	€	€	----	●
GS 40 LS	●	□	□	€	●	€	€	€	----	●
GS 40 LS D	●	□	□	€	●	€	€	€	----	●
GS 50 ECO	●	----	----	€	●	----	€	€	----	●
GS 50*	□	●	□	€	●	€	€	€	----	●
GS 50 D	□	●	□	€	●	€	€	€	----	●
GS 40 T	●	----	----	€	●	----	€	€	●	●
GS 40 T DA	●	----	----	€	●	----	€	€	●	●
GS 40 T LS	●	----	----	€	●	----	€	€	●	●
GS 40 T LS DA	●	----	----	€	●	----	€	€	●	●
GS 50 T	□	●	□	€	●	€	€	€	●	●
GS 50 T DA	□	●	□	€	●	€	€	€	●	●
GS 85 T	€	●	□	€	●	----	€	€	●	●
GS 85 T DA	€	●	□	€	●	----	€	€	●	●

D Built-in water softener

DA Built-in automatic water softener

LS Upper wash

T LED electronic (SOFT TOUCH)

● Standard

---- Not available

□ Upon request

* Construction according to UL-NSF standards upon request

XP Recommended with water 8-55 °C. For GS 40 with three-phase voltage only, GS 50 with standard voltage only
For other voltages please contact us

	DBE	FS	PS + FS	CR	PS + DDE + FS	TS	BT	WRAS	PAP
Model	Peristaltic Rinse-Aid Disp.	Cold Rinse	PS + FS	Round Basket	PS + DDE + FS	Thermostop System	Break Tank	Wras	Booster pump
GS 35	€	€	€	€	€	●	----	----	----
GS 35 D	€	----	----	€	----	●	----	----	----
GS 37	€	€	€	€	€	●	----	----	----
GS 37 D	€	----	----	€	----	●	----	----	----
GS 37 LS	€	€	€	€	€	●	----	----	----
GS 37 LS D	€	----	----	€	----	●	----	----	----
GS 40	€	€	€	€	€	●	----	----	----
GS 40 D	€	----	----	€	----	●	----	----	----
GS 40 LS	€	€	€	€	€	●	----	----	----
GS 40 LS D	€	----	----	€	----	●	----	----	----
GS 50 ECO	€	----	----	----	----	●	----	----	----
GS 50*	€	€	€	----	€	●	€	€	€
GS 50 D	€	€	----	----	----	●	----	----	----
GS 40 T	€	€	€	€	€	●	----	----	----
GS 40 T DA	€	€	€	€	----	●	----	----	----
GS 40 T LS	€	€	€	€	€	●	----	----	----
GS 40 T LS DA	€	€	€	€	€	●	----	----	----
GS 50 T	€	€	€	----	€	●	€	€	€
GS 50 T DA	€	€	€	----	€	●	----	----	----
GS 85 T	€	€	€	----	€	●	€	€	€
GS 85 T DA	€	€	----	----	----	●	----	----	€

SOFT START

Progressive start of the wash pump

BT - WRAS

Booster pump included

220-240 V 50 HZ

For GS 50 and GS 85 max boiler heating element 4500 W

380-415 V 3N 50 HZ

For GS 40 with extra power only



220-240 V 3 50 HZ



For GS 40 LS D with special voltage and PS, DDE is not available

Option compatibility to be confirmed by the manufacturer after verification

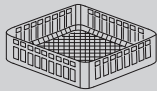
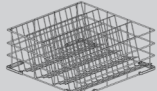
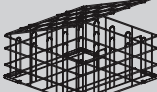
Water supply 55 °C

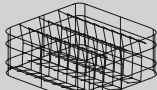
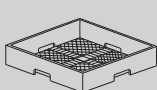
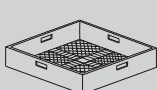
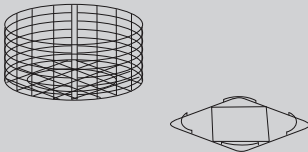
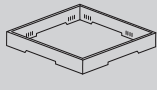
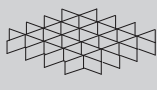
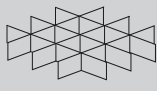
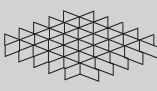
EAC label upon request

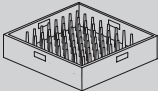
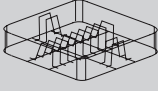
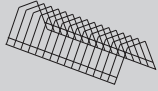
	Description	Capacity	Dimensions	Code
	GLASS BASKET		350x350x110 H 400x400x135 H 370x370x130 H	10730 C 121 C 10
	SLOPED GLASS BASKET	Ø 85 max Ø 100 max	370x370x210 H 500x500x200 H	C 39 C 26
	REUSABLE CUP BASKET	5x5 glasses 30 mm < Ø < 90 mm H max 185 mm	500x500x235 H	C 135 
	SLOPED GLASS BASKET	Ø 90 max Ø 120 max	400x400x185 H 400x400x160 H	C 123 C 79
	NARROW MESH CUTLERY BASKET		500x500x106 H	C 41
	LARGE MESH BASKET	For glasses	500x500x105 H	C 44
	ROUND GLASS BASKET	Basket	Ø 350x105 H	C 21
	ROUND BASKET SUPPORT	Support	350x350	C 36
		Basket	Ø 370x120 H	C 07
		Support	370x370	C 37
		Basket	Ø 400x145 H	C 16
		Support	400x400	C 38
	HOLDER FOR GLASS SUPPORT	For glass support (C112-C113-C114)	500x500x50 H	C 111
	GLASS SUPPORT	5x5 Glass Ø 87 mm (C111)	500x500x50 H	C 112
	GLASS SUPPORT	4x4 Glass Ø 110 mm (C111)	500x500x50 H	C 113
	GLASS SUPPORT	6x6 Glass Ø 72 mm (C111)	500x500x50 H	C 114

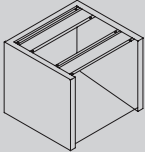
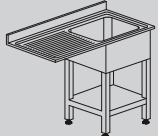
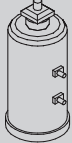
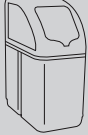
	Description	Capacity	Dimensions	Code	
	PLATE BASKET	18 Plates	500x500x105 H	C 40	
	PLATE BASKET	10 Plates	370x370x100 H	C 03	
		12 Plates	400x400x120 H	C 31	
	SAUCER HOLDER	14 Saucers	300x100x90 H	10728	
	CUTLERY BASKET		Ø 120x120 H	15060	
	SUPPORT	Stainless steel stand	592x535x500 H	999900517	
	SINK UNIT FOR UNDER-COUNTER MODELS	Sink 500x400x300H	1200x700x850 H	A 20	
	WATER SOFTENER	12 l	Ø 200x500 H	D 1	
	AUTOMATIC WATER SOFTENER	12 l (max 800 l)	315x510x685 H	D 2	

* Wooden cage +2% minimum €

Special dimensions for tables upon request

Tables shown in right-to-left version



Double wall glass and dishwashers DS line. Designed to meet the needs of bars, restaurants, hotels and pubs. Their aesthetics has been renewed; electro-mechanic and electronic version are available.

A wide choice of options may be chosen amongst, water softener, detergent dispenser, drain pump and the surface filters in order to adapt the machine to the most diverse uses.











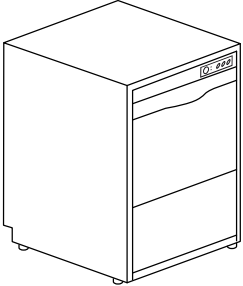



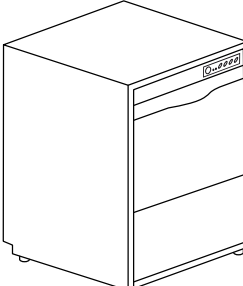

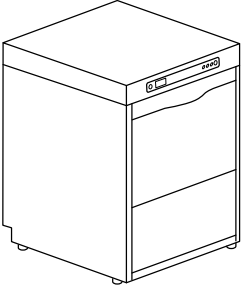

ELECTRONIC VERSION

An electronic control panel is available for DS T models. The LED panel displays the temperatures of both tank and boiler, the wash cycle and status and main alarm codes for malfunctions. You can now choose among four different washing programs to perfectly tailor the performances of the machine to the crockery that needs to be cleaned. The soft start function grants extra protection for fragile objects.

FEATURES

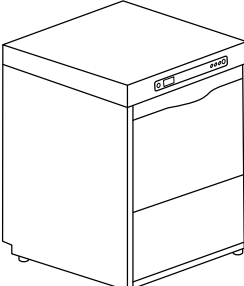
- Double walled AISI 304 structure
- Pressed basket supports
- Double skin door with anti-shock system
- Deep-drawn and sloped tank for a perfect total drain
- Overflow and drain pipes integrated system, for a triple protection of the washing pump
- Non-drip roof to safeguard the hygiene of the freshly washed dishes
- Light wash and rinse arms, granting the best efficiency also in the event of weak pressure in the water mains (DS 40)
- S/S wash arms (DS 50 and DS 50 T)
- Easy to remove nozzles, to help with daily cleaning operations
- Back flow prevention valve
- Rinse-aid dispenser (peristaltic version on demand)
- Thermostop system: the rinse starts only when the water in boiler reaches 85 °C
- CE Certified components
- Electronic version with four preset washing programs
- Automatic regeneration for touch models with built-in water softener
- Glasswashers available also with round basket
- Self-cleaning cycle on the TOUCH versions
- Soft Start wash pump on the TOUCH versions
- Additional upper surface filter (on demand only for DS 50 and DS 50 T)

Model		Voltage	Capacity	Dimensions	Code
DS 40	UPPER WASH - 1 PROGRAM				
	<p>RACK EQUIPMENT</p> <ul style="list-style-type: none"> 2 X C121 1 X 10728 1 X 15060 	230 V ~ 50 Hz 3,2 kW	 305 H  Ø 295  400x400	460x545x715 H 38 kg	<p>DS 40</p> <p>DS 40 D</p>
DS 50	2 PROGRAMS				
	<p>RACK EQUIPMENT</p> <ul style="list-style-type: none"> 1 X C40 1 X C44 1 X 15060 	400 V 3N~ 50 Hz 5,2 kW	 310 H  Ø 325  500x500	595x610x845 H 61 kg	<p>DS 50</p> <p>DS 50 D</p> <p>Surface filters</p>

Model	Voltage	Capacity	Dimensions	Code
DS 40 T	UPPER WASH - ELECTRONIC 4 PROGRAMS			
	<p>RACK EQUIPMENT 2 X C121 1 X 10728 1 X 15060</p> 	<p>230 V ~ 50 Hz 3,2 kW</p>	<p>305 H</p>  <p>Ø 295</p>  <p>400x400</p> 	<p>460x545x715 H 38 kg</p> <p>DS 40 T</p> <p>DS 40 T DA</p>
DS 50 T	ELECTRONIC 4 PROGRAMS			
	<p>RACK EQUIPMENT 1 X C40 1 X C44 1 X 15060</p> 	<p>400 V 3N ~ 50 Hz 5,2 kW</p>	<p>310 H</p>  <p>Ø 325</p>  <p>500x500</p> 	<p>595x610x845 H 61 kg</p> <p>DS 50 T</p> <p>DS 50 T DA</p> <p>Surface filters</p>

OPTIONS

						XP	PS	DDE	DB	ST
Model	220-240 V 50 Hz	380-415 V 3N 50 Hz	220-240 V 3 50 Hz	60 Hz	Electronic timer	Extra Power	Drain Pump	Detergent Dispenser	Rinse-Aid Dispenser	Soft Start
DS 40	●	□	□	€	●	€	€	€	●	----
DS 40 D	●	□	□	€	●	€	€	€	●	----
DS 50 *	□	●	□	€	●	€	€	€	●	----
DS 50 D	□	●	□	€	●	€	€	€	●	----
DS 40 T	●	----	----	€	●	----	€	€	●	●
DS 40 T DA	●	----	----	€	●	----	€	€	●	●
DS 50 T	□	●	□	€	●	€	€	€	●	●
DS 50 T DA	□	●	□	€	●	€	€	€	●	●

D Built-in water softener

DA Built-in automatic water softener

LS Upper wash

T LED electronic (SOFT TOUCH)

● Standard

---- Not available

□ Upon request

* Construction according to UL-NSF standards upon request

XP Recommended with water 8-55 °C. For DS 40 only with three-phase voltage, DS 50 only with standard voltage.
For other voltages please contact us

	DBE	CR	FS	PS + FS	PS + DDE + FS	TS	BT	WRAS	PAP
Model	Peristaltic Rinse-Aid Disp.	Round Basket	Cold Rinse	PS + FS	PS + DDE + FS	Thermostop System	Break Tank	Wras	Booster pump
DS 40	€	€	€	€	€	●	----	----	----
DS 40 D	€	€	----	----	----	●	----	----	----
DS 50 *	€	----	€	€	€	●	€	€	€
DS 50 D	€	----	----	----	----	●	----	----	€
DS 40 T	€	€	€	€	€	●	----	----	----
DS 40 T DA	€	€	€	€	€	●	----	----	----
DS 50 T	€	----	€	€	€	●	€	€	€
DS 50 T DA	€	----	€	€	€	●	----	----	----

SOFT START Progressive start of the wash pump

BT - WRAS Booster pump included

220-240 V 50 HZ For DS 50 max boiler heating element 4500 W



380-415 V 3N 50 HZ For DS 40 only with extra power



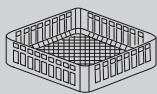
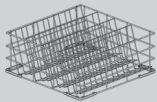
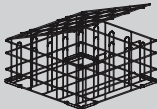

220-240 V 3 50 HZ For DS 40 D with special voltage and PS, DDE is not available

Option compatibility to be confirmed by the manufacturer after verification

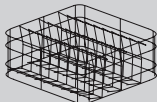
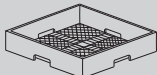
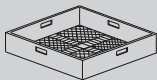
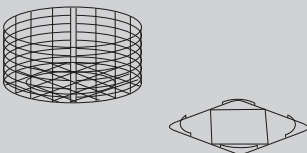
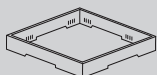
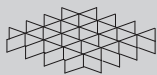
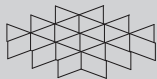
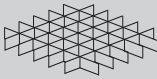
Water supply 55 °C

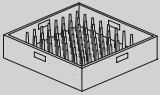
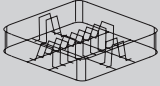
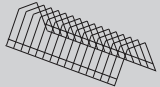
EAC label upon request

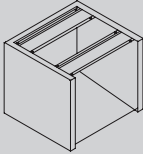
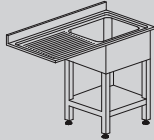
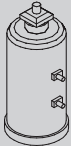
	Description	Capacity	Dimensions	Code
	GLASS BASKET		350x350x110 H 400x400x135 H 370x370x130 H	10730 C 121 C 10
	SLOPED GLASS BASKET	Ø 85 max Ø 100 max	370x370x210 H 500x500x200 H	C 39 C 26
	REUSABLE CUP BASKET	5x5 glasses 30 mm < Ø < 90 mm H max 185 mm		C 135 
	SLOPED GLASS BASKET	Ø 90 max Ø 120 max	400x400x185 H 400x400x160 H	C 123 C 79
	NARROW MESH CUTLERY BASKET		500x500x106 H	C 41
	LARGE MESH BASKET	For glasses	500x500x105 H	C 44
	ROUND GLASS BASKET ROUND BASKET SUPPORT	Basket Support Basket Support Basket Support	Ø 350x105 H 350x350 Ø 370x120 H 370x370 Ø 400x145 H 400x400	C 21 C 36 C 07 C 37 C 16 C 38
	HOLDER FOR GLASS SUPPORT	For glass support (C112-C113-C114)	500x500x50 H	C111
	GLASS SUPPORT	5x5 Glass Ø 87 mm (C 111)	500x500x50 H	C 112
	GLASS SUPPORT	4x4 Glass Ø 110 mm (C 111)	500x500x50 H	C 113
	GLASS SUPPORT	6x6 Glass Ø 72 mm (C 111)	500x500x50 H	C 114

	Description	Capacity	Dimensions	Code	
	PLATE BASKET	18 Plates	500x500x105 H	C 40	
	PLATE BASKET	10 Plates	370x370x100 H	C 03	
		12 Plates	400x400x120 H	C 31	
	SAUCER HOLDER	14 Saucers	300x100x90 H	10728	
	CUTLERY BASKET		Ø 120x120 H	15060	
	STAND	Stainless steel stand	592x535x500 H	999900517	
	SINK UNIT FOR UNDER-COUNTER MODELS	Sink 500x400x300H	1200x700x850 H	A 20	
	WATER SOFTENER	12 l	Ø 200x500 H	D 1	
	AUTOMATIC WATER SOFTENER	12 l (max 800 l)	315x510x685 H	D 2	

* Wooden cage +2% minimum + €

Special dimensions for tables upon request

Tables shown in right-to-left version



Latest generation DIHR dishwashers. These machines are built with fully double-skin body, completely deep-formed, designed for being silent and reliable. Beside the standard electronic versions with four programmable cycles, we have developed the PLUS models with guaranteed steady rinse temperature and pressure and two

cycles with HYGIENE+ superior features (ELECTRON 500). Thanks to these latest technological features, the sturdy PLUS versions will promote the almost total elimination of the bacterial load. The customization of our new generation machines has never been so easy!

$A_0=30$
HYGIENE+

HYGIENE+ SYSTEM

The HYGIENE+ models perform long cycles at high temperatures to fulfill high levels of hygiene, now more essential than ever for our health. Designed and conceived upon rigorous disinfection parameters, the HYGIENE+ models include 2 special cycles complying with $A_0=30$ on the scale of thermo-disinfection according to the norm EN ISO 15883-1, a short one program of 180 seconds and a longer one of 630 seconds, ensuring compliance with high levels of hygiene thanks to high temperatures and long cycles.

FEATURES

- Double skin AISI 304 machine and double skin insulated door
- Sloped deep-formed tank
- Wash arms in stainless steel with unblockable nozzles and lightweight rinse arms in composite material
- Deep-formed rack supports
- Anti-drop roof panel
- Suitable for Gastronorm 1/1 trays
- Multivoltage models
- Detergent and rinse-aid dosage setting, directly from the control panel (PLUS models)
- Wash and rinse temperatures displayed
- Anti back-flow valve available also DVGW or WRAS certified)
- Double tight-mesh filter system in stainless steel
- Programmable wash cycles (not on ELECTRON 1000 PLUS)
- HYGIENE+ Version: 2 special additional programs complying with $A_0=30$ according to the norm EN ISO 15883-1
- Intuitive START button with multicolour backlight for a quick visualization of the machine status
- Self-cleaning cycle
- Soft Start wash pump
- Thermal insulation of boiler
- Soft door opening and programmable START function when the door gets closed
- OPTIMAL-RINSE (optimal rinse technology): water consumption rate among the lowest on the market, consequent reduction of electricity and chemicals consumptions
- Built-in peristaltic detergent dispenser and built-in rinse-aid dispenser (peristaltic rinse-aid dispenser included in the PLUS versions)
- Water consumption and working time control system (PLUS versions)
- PLUS system for extra rinse guarantee (PLUS versions)
- Built-in automatic water softener available
- CONNECTIVITY remote control compliant with the HACCP norms (on request)
- Cold water rinse (on demand)
- Reverse osmosis connection for external device (PLUS versions)



CONNECTIVITY 4.0 & APP

WHEREVER YOU ARE...

YOUR DISHWASHER, JUST A CLICK AWAY

You will be constantly connected to the machine to monitor the work phases, review any eventual alarm and configure remotely the operating parameters according to your needs. Compliant with HACCP norms. Thanks to our brand new App, you will have access to connected machines and all commercial and technical documentation.

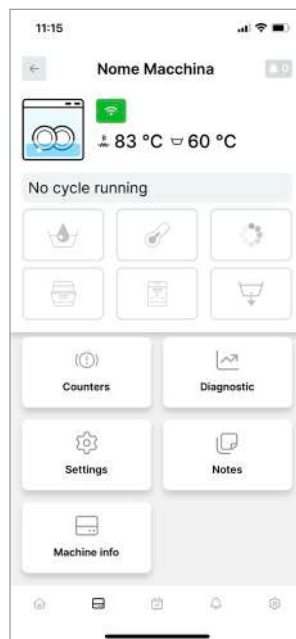

View all the working parameters and event records, working hours and any problem at any time.



In case of problem, the machine promptly alerts you. The technician can intervene remotely to solve the problem or anticipate the needed parts for an on-site intervention.



A daily activity report is available with all the events related to the dishwasher in a detailed spreadsheet with HACCP data.



Our Connectivity system is a revolutionary device limiting and facilitating the eventual intervention of a technician who can anticipate the necessary parts to be replaced, saving time and money.

PLUS SYSTEM

GUARANTEED RINSE EVEN
WITH LOW PRESSURE OF THE WATER INLET

We have developed an innovative rinsing system at constant temperature, consumption and water pressure, regardless of external conditions.

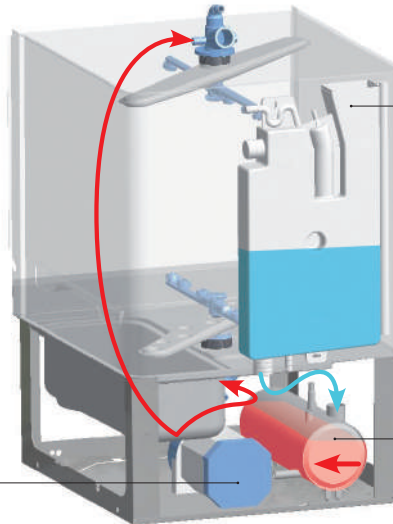

RINSE PUMP

The water is sucked from the boiler through a rinse pump and is sent to the rinse nozzles. The correct pressure is ensured regardless of the water inlet pressure and temperature.

BREAK TANK

The Break Tank system prevents the heated water of the boiler to go back and mix with the fresh water supply.

ATMOSPHERIC BOILER

The water temperature in the boiler remains constant at 85°C throughout the rinse, as the boiler refill only occurs once the rinse cycle is done.



STABILIZED PRESSURE
THROUGHOUT THE RINSE PHASE













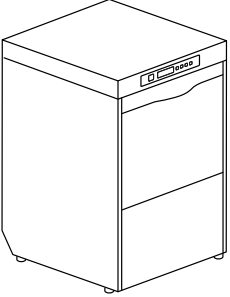







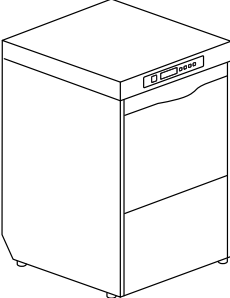

STEADY WATER
TEMPERATURE IN THE
BOILER (85°C)





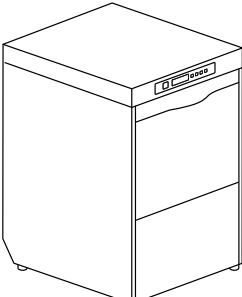





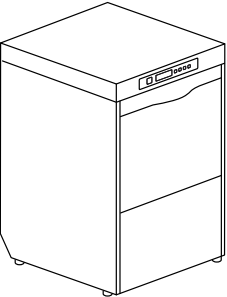



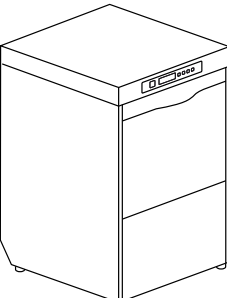

CLEANER WATER
LESS WASTE

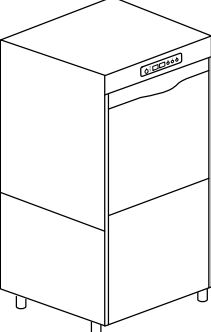
ELECTRON

HIGH-TECH DOUBLE SKIN
GLASS & DISHWASHERS

Model	Voltage	Capacity	Dimensions	Code	
ELECTRON 400 ELECTRONIC 4 PROGRAMS					
	<p>RACK EQUIPMENT</p> <ul style="list-style-type: none"> 2 X C121 1 X 10728 1 X 15060 	<p>Multivoltage</p> <p>standard</p> <p>230 V 50 Hz 3,05 kW</p> <p>--</p> <p>230 V 3 50 Hz 4,45 kW</p> <p>--</p> <p>400 V 3N 50 Hz 4,45 kW</p>	<p> 310 H</p> <p> ø 310</p> <p> 400x400</p>	<p>460x550x780 H 45 kg</p>	<p>ELECTRON 400</p> <p>ELECTRON 400 DA</p>
		<p>Multivoltage</p> <p>standard</p> <p>400 V 3N 50 Hz 5,15 kW</p> <p>--</p> <p>230 V 3 50 Hz 5,15 kW</p> <p>--</p> <p>230 V 50 Hz 5,15 kW</p>	<p> 325 H</p> <p> ø 340</p> <p> 500x500</p>	<p>600x610x850 H 63,5 kg</p> <p> GN 1/1</p> <p>530x325x25 H</p>	<p>ELECTRON 500</p> <p>ELECTRON 500 DA</p>
ELECTRON 500 H+ ELECTRONIC 4 PROGRAMS					
	<p>A₂-30 HYGIENE +</p> <p>RACK EQUIPMENT</p> <ul style="list-style-type: none"> 1 X C40 1 X C44 1 X 15060 	<p>Multivoltage</p> <p>standard</p> <p>400 V 3N 50 Hz 5,15 kW</p> <p>--</p> <p>230 V 3 50 Hz 5,15 kW</p> <p>--</p> <p>230 V 50 Hz 5,15 kW</p>	<p> 325 H</p> <p> ø 340</p> <p> 500x500</p>	<p>600x610x850 H 63,5 kg</p> <p> GN 1/1</p> <p>530x325x25 H</p>	<p>ELECTRON 500 H+</p> <p>ELECTRON 500 DA H+</p>
		<p>Multivoltage</p> <p>standard</p> <p>400 V 3N 50 Hz 6,7 kW</p> <p>--</p> <p>230 V 3 50 Hz 6,7 kW</p> <p>--</p> <p>230 V 50 Hz 6,7 kW</p>	<p> 400 H</p> <p> ø 400</p> <p> 500x500</p>	<p>600x680x850 H 68 kg</p> <p> GN 1/1</p> <p>530x325x25 H</p>	<p>ELECTRON 600</p> <p>ELECTRON 600 DA</p> <p>Surface filters</p>
ELECTRON 600 ELECTRONIC 4 PROGRAMS					
	<p>RACK EQUIPMENT</p> <ul style="list-style-type: none"> 1 X C40 1 X C44 1 X 15060 	<p>Multivoltage</p> <p>standard</p> <p>400 V 3N 50 Hz 6,7 kW</p> <p>--</p> <p>230 V 3 50 Hz 6,7 kW</p> <p>--</p> <p>230 V 50 Hz 6,7 kW</p>	<p> 400 H</p> <p> ø 400</p> <p> 500x500</p>	<p>600x680x850 H 68 kg</p> <p> GN 1/1</p> <p>530x325x25 H</p>	<p>ELECTRON 600</p> <p>ELECTRON 600 DA</p> <p>Surface filters</p>

Model	Voltage	Capacity	Dimensions	Code	
ELECTRON 400 PLUS ELECTRONIC 4 PROGRAMS					
	RACK EQUIPMENT 2 X C121 1 X 10728 1 X 15060	Multivoltage standard 230 V 50 Hz 3,05 kW	 310 H	ELECTRON 400 PLUS	
		230 V 3 50 Hz 4,45 kW	 ø 310	460x550x780 H 46,5 kg	ELECTRON 400 PLUS DA
		400 V 3N 50 Hz 4,45 kW	 400x400		ELECTRON 400 PLUS HR
		HR: Cold water supply			ELECTRON 400 PLUS HR DA
ELECTRON 500 PLUS H+ ELECTRONIC 6 PROGRAMS					
	RACK EQUIPMENT 1 X C40 1 X C44 1 X 15060	Multivoltage standard 400 V 3N 50 Hz 5,15 kW	 325 H	ELECTRON 500 PLUS H+	
		230 V 3 50 Hz 5,15 kW	 ø 340	600x610x850 H 65 kg	ELECTRON 500 PLUS DA H+
		230 V 50 Hz 5,15 kW	 500x500	 530x325x25 H	ELECTRON 500 PLUS HR H+
		HR: Cold water supply			ELECTRON 500 PLUS HR DA H+
ELECTRON 1000 PLUS ELECTRONIC 4 PROGRAMS					
	RACK EQUIPMENT 1 X C40 1 X C43 1 X C44 1 X 15060	400 V 3N ~ 50 Hz 10,2 kW	 440 H	600x700x1380 H 87 kg	
			 ø 450	 600x400x25 H	
			 500x500	 530x325x25 H	
				ELECTRON 1000 PLUS	

A₀=30 Special programs complying with A₀=30 on the scale of thermo-disinfection according to the norm EN ISO 15883-1. The Hygiene+ models include 2 special cycles, a short one of 180 seconds and a longer one of 630 seconds, ensuring compliance with high levels of hygiene thanks to high temperatures and long cycles.

PLUS Rinse with constant temperature, pressure and stabilized consumption

X With special basket to be ordered

OPTIONS

Model	220-240 V 50 Hz	380-415 V 3N 50 Hz	220-240 V 3 50 Hz	380-415 V 3 50 Hz	440 V 3 60 Hz	60 Hz	RO Osmosis Connection	XP Extra Power	PS Drain Pump	DDE Det. Dispenser	DB Rinse- Aid disp.	DBE Peristaltic Rinse-Aid Disp.
ELECTRON 400	●	M	M	----	----	€	----	□	€	●	●	€
ELECTRON 400 DA	●	M	M	----	----	€	----	□	€	●	●	€
ELECTRON 500	M	●	M	€	€	€	----	€	€	●	●	€
ELECTRON 500 DA	M	●	M	----	----	€	----	€	€	●	●	€
ELECTRON 500 H+	M	●	M	€	€	€	----	€	€	●	●	€
ELECTRON 500 DA H+	M	●	M	----	----	€	----	€	€	●	●	€
ELECTRON 600	□	●	M	----	----	€	----	----	€	●	●	€
ELECTRON 600 DA	□	●	M	----	----	€	----	----	€	●	●	€
ELECTRON 400 PLUS	●	M	M	----	----	€	□	€	€	●	----	●
ELECTRON 400 PLUS DA	●	M	M	----	----	€	----	€	€	●	----	●
ELECTRON 400 PLUS HR	●	M	M	----	----	€	□	€	€	●	----	●
ELECTRON 400 PLUS HR DA	●	M	M	----	----	€	----	€	€	●	----	●
ELECTRON 500 PLUS H+	M	●	M	€	€	€	□	€	€	●	----	●
ELECTRON 500 PLUS DA H+	M	●	M	----	----	€	----	€	€	●	----	●
ELECTRON 500 PLUS HR H+	M	●	M	€	€	€	□	€	€	●	----	●
ELECTRON 500 PLUS HR DA H+	M	●	M	----	----	€	----	€	€	●	----	●
ELECTRON 1000 PLUS	€	●	□	----	----	€	□	€	€	●	----	●

● Standard

---- Not available

□ Upon request

DA Built-in automatic water softener

M Multivoltage

XP Recommended with water 8-55 °C, for ELECTRON 400 models only with standard voltage for other voltages please contact us

Water supply 55 °C (except HR versions)

EAC label upon request

	ST	FS	CR	PS+FS	TS	CONNECTIVITY	BT	WRAS	DVGW	PAP	FLOAT
Model	Soft start	Cold Rinse	Round Basket	PS + FS	Electr. Timer +Thermostop	Connectivity (HACCP)	Break Tank	Wras	DVGW	Booster Pump	Probes lack det and rinse aid
ELECTRON 400	●	€	€	€	●	€	€	€	€	€	€
ELECTRON 400 DA	●	----	€	----	●	€	----	----	----	€	€
ELECTRON 500	●	€	----	€	●	€	€	€	€	€	€
ELECTRON 500 DA	●	----	----	----	●	€	----	€	€	€	€
ELECTRON 500 H+	●	€	----	€	●	€	€	€	€	€	€
ELECTRON 500 DA H+	●	----	----	----	●	€	----	€	€	€	€
ELECTRON 600	●	€	----	€	●	€	€	€	----	€	€
ELECTRON 600 DA	●	----	----	----	●	€	----	€	----	----	€
ELECTRON 400 PLUS	●	€	€	€	●	€	●	€	€	●	€
ELECTRON 400 PLUS DA	●	----	€	----	●	€	----	----	----	●	€
ELECTRON 400 PLUS HR	●	----	€	----	●	€	●	----	----	●	€
ELECTRON 400 PLUS HR DA	●	----	€	----	●	€	----	----	----	●	€
ELECTRON 500 PLUS H+	●	€	----	€	●	€	●	€	€	●	€
ELECTRON 500 PLUS DA H+	●	----	----	----	●	€	----	€	€	●	€
ELECTRON 500 PLUS HR H+	●	----	----	----	●	€	●	----	----	●	€
ELECTRON 500 PLUS HR DA H+	●	----	----	----	●	€	----	----	----	●	€
ELECTRON 1000 PLUS	●	----	----	----	●	----	●	€	€	●	€

380-415 V 3N 50 HZ For the models ELECTRON 400 "upon request" provide extra power
220-240 V 3 50 HZ

220 -240 V 50 HZ For the models ELECTRON 1000 PLUS max boiler heating element 6000W

CONNECTIVITY Includes HACCP option. 10-year plan

BT - WRAS Booster pump included





DVGW Components prescribed by DVGW on request (check option compatibility with the manufacturer)



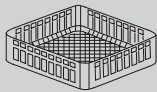
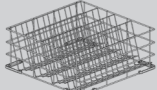
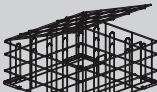

SOFT START Progressive start of the wash pump

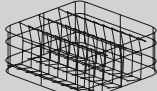
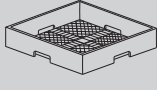
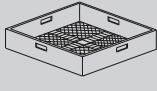
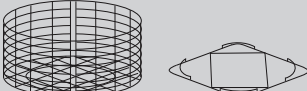
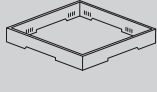
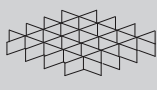
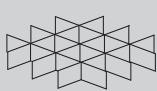
H+ (HYGIENE+) 2 cycles of 630 and 180 seconds with high temperatures, reaching up to 70 °C for washing and 90 °C for rinsing
 Option compatibility to be confirmed by the manufacturer after verification

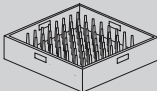
All models: independent wash and rinse arms

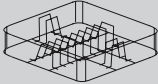
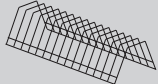
Option compatibility to be confirmed by the manufacturer after verification

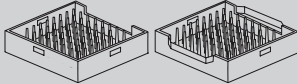
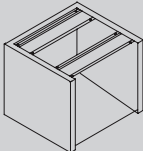
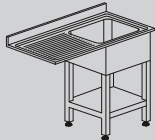
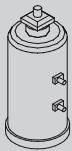
	Description	Capacity	Dimensions	Code	
	GLASS BASKET		400x400x135 H	C 121	
	SLOPED GLASS BASKET	Ø 100 max	500x500x200 H	C 26	
	REUSABLE CUP BASKET	5x5 glasses 30 mm <math>< \lt; 90 \text{ mm}</math> H max 185mm	500x500x235 H	C 135 	
	SLOPED GLASS BASKET	Ø 90 max	400x400x185 H	C 123	
		Ø 120 max	400x400x160 H	C 79	
	NARROW MESH CUTLERY BASKET		500x500x106 H	C 41	
	LARGE MESH BASKET	For glasses	500x500x105 H	C 44	
	ROUND GLASS BASKET	Basket	Ø 400x145 H	C 16	
	ROUND BASKET SUPPORT	Support	400x400	C 38	
	HOLDER FOR GLASS SUPPORT	For glass support (C112-C113-C114)	500x500x50 H	C111	
	GLASS SUPPORT	5x5 Glass Ø 87 mm (C111)	500x500x50 H	C 112	
	GLASS SUPPORT	4x4 Glass Ø 110 mm (C111)	500x500x50 H	C 113	
	GLASS SUPPORT	6x6 Glass Ø 72 mm (C111)	500x500x50 H	C 114	
	PLATE BASKET	18 Plates	500x500x105 H	C 40	

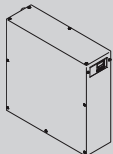
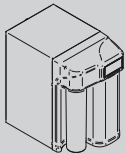
	Description	Capacity	Dimensions	Code	
	PLATE BASKET	12 Plates	400x400x120 H	C 31	
	SAUCER HOLDER	14 Saucers	300x100x90 H	10728	
	CUTLERY BASKET		Ø 120x120 H	15060	
	GASTRONORM TRAYS BASKET	6 pcs, max. depth 25 mm	500x500x105 H 500x500x105 H	C 43 C 43/B	
	STAND	Stainless steel stand	592x535x500 H	999900517	
	SINK UNIT FOR UNDER-COUNTER MODELS	Sink 500x400x300H	1200x700x850 H	A 20*	
	WATER SOFTENER	12 l	Ø 200x500 H	D 1	
	AUTOMATIC WATER SOFTENER	12 l (max 800 l)	315x510x685 H	D 2	
	OSMOSIS FOR ELECTRON 400 PLUS MODELS	230 V 50 Hz - 250 W 5° C - 30° C Flow rate 180-210l/h - 15°C Not suitable for machine with integrated water softener Special basket dotation	145x560x580 H 25 Kg	OS 180	
	OSMOSIS FOR ELECTRON 500 PLUS MODELS	230 V 50 Hz - 250 W 5° C - 30° C Flow rate 240 l/h Not suitable for machine with integrated water softener Special basket dotation	270x411x451 H 18 Kg	OS 240	

* Wooden cage +2% minimum + €

Special dimensions for tables upon request

Tables shown in right-to-left version



We simply combined the highest specs and ultimate new technology to the time-tested name and features. OPTIMA is our answer to the new high standards of hygiene and cleanliness of the worldwide market, keeping our renowned low operating costs thanks to the OPTIMAL RINSE system. Our HYGIENE+ cycles will guarantee to work safely by keeping top sanitation levels. The compact model with lower usable height, the settable additional cycle and the available self-mon-

itoring technology and Connectivity makes the OPTIMA the range you have been expecting. An intuitive and interactive electronic panel will lead you through the new functions of your dishwasher. Its self-diagnosis system notifies any anomaly and clearly shows the different steps of the cycle and status of your dishwasher. Eight wash cycles (ten for the HYGIENE+ version) and the easy change of voltage make these machines incredibly versatile and easy to install.

$A_0=60$
HYGIENE+

HYGIENE+ SYSTEM

Our HYGIENE + models, with high temperatures and long cycles, ensure compliance with high levels of hygiene, nowadays more essential than ever for our personal health. We designed this range according to strict standards and parameters of thermal disinfection. All our HYGIENE + models obtain the A_0 60 level, reducing pathogenic microorganisms and bacterial load according to the norm EN ISO 15883-1. Two cycles with high temperatures (180 and 630 seconds), reaching up to 75°C for washing and 90°C for rinsing, guarantee a full compliance with the disinfection principles.



FEATURES

- OPTIMAL-RINSE (optimal rinse technology): water consumption rate among the lowest on the market, consequent reduction of electricity and chemicals consumptions
- Soft door opening and programmable START function when the door gets closed
- Combined system of wash and rinse arms in stainless steel with unblockable nozzles
- Innovative S/S filter improving the filtration of the wash water
- Partial drain of the waste wash water before rinsing
- Standard version: Eight wash cycles, six with partial drain of the wash water and two with total drain of the wash water before rinsing
- HYGIENE+ version: Ten wash cycles, six with partial drain of the wash water, two with total drain of the wash water before rinsing and two HYGIENE+ programs
- Double skin machine and double skin insulated door
- Electronic control panel with TFT screen and multichromatic START key to instantly view all functions
- Self-diagnostic system with two different control levels for user and service people depending on the failure
- Easy-change voltage setting, directly from the cables connection
- Water consumption and working time control system
- Detergent and rinse-aid peristaltic dispensers included
- Detergent and rinse-aid dosage setting, directly from the control panel
- Built-in drain pump
- Thermostop with Energy Saving device
- Self-cleaning cycle
- Soft Start wash pump
- Thermal insulation of boiler
- CONNECTIVITY remote control compliant with the HACCP norms (on request)
- Automatic softened version with continuous self-regeneration

CONNECTIVITY 4.0 & APP

WHEREVER YOU ARE...
YOUR DISHWASHER, JUST A CLICK AWAY

You will be constantly connected to the machine to monitor the work phases, review any eventual alarm and configure remotely the operating parameters according to your needs. Compliant with HACCP norms. Thanks to our brand new App, you will have access to connected machines and all commercial and technical documentation.

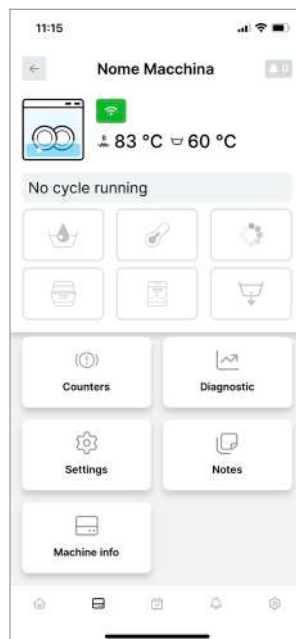

View all the working parameters and event records, working hours and any problem at any time.



In case of problem, the machine promptly alerts you. The technician can intervene remotely to solve the problem or anticipate the needed parts for an on-site intervention.



A daily activity report is available with all the events related to the dishwasher in a detailed spreadsheet with HACCP data.



Our Connectivity system is a revolutionary device limiting and facilitating the eventual intervention of a technician who can anticipate the necessary parts to be replaced, saving time and money.

PLUS SYSTEM

GUARANTEED RINSE EVEN

WITH LOW PRESSURE OF THE WATER INLET

We have developed an innovative rinsing system at constant temperature, consumption and water pressure, regardless of external conditions.



STEADY WATER TEMPERATURE IN THE BOILER (85°C)



STABILIZED PRESSURE THROUGHOUT THE RINSE PHASE



CLEANER WATER
LESS WASTE

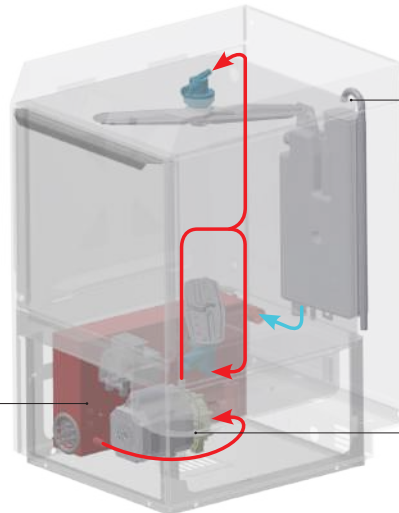

BREAK TANK

The Break Tank system prevents the heated water of the boiler to go back and mix with the fresh water supply.

ATMOSPHERIC BOILER

The water temperature in the boiler remains constant at 85°C throughout the rinse, as the boiler refill only occurs once the rinse cycle is done.

RINSE PUMP

The water is sucked from the boiler through a rinse pump and is sent to the rinse nozzles. The correct pressure is ensured regardless of the water inlet pressure and temperature.

ENERGY RECOVERY











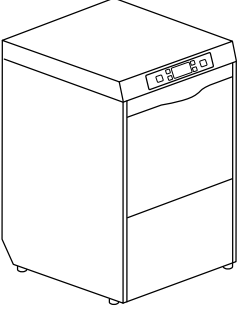

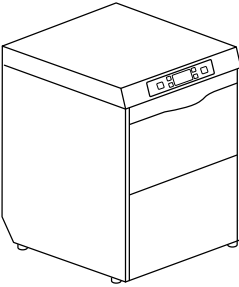

(Heat recovery and steam condenser)



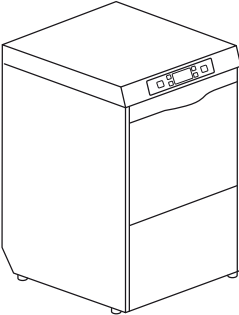

The ENERGY RECOVERY system uses the heat produced by the machine to preheat the inlet cold water. This is an immediate saving on energy costs. Additionally, an optimal temperature in the dishwashing area is achieved as the air is no more affected by steam and humidity.

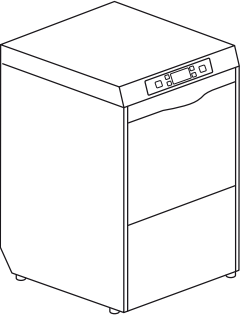

Heat Recovery

CONNECTED GLASS AND DISHWASHERS
WITH CLEAN WATER TECHNOLOGY

Model		Voltage	Capacity	Dimensions	Code	
OPTIMA 400 ELECTRONIC 8 PROGRAMS						
	<p>RACK EQUIPMENT 2 X C121 1 X 10728 1 X 15060</p> 	Multivoltage			OPTIMA 400	
		standard 230 V 50 Hz 3,25 kW	 310 H	460x550x780 H 47 kg	OPTIMA 400 DA	
		-- 230 V 3 50 Hz 4,75 kW	 Ø 310		OPTIMA 400 HR	
		400 V 3N 50 Hz 4,75 kW	 400x400		OPTIMA 400 HR DA	
HR: Cold water supply						
OPTIMA 500 SMALL ELECTRONIC 8 PROGRAMS						
	<p>RACK EQUIPMENT 1 X C40 1 X C44 1 X 15060</p> 	Multivoltage			OPTIMA 500 SMALL	
		standard 400 V 3N 50 Hz 6,35 kW	 260 H	600x610x730 H 60 kg	OPTIMA 500 SMALL DA	
		-- 230 V 3 50 Hz 6,35 kW	 Ø 260		OPTIMA 500 SMALL HR	
		230 V 50 Hz 6,35 kW	 500x500		OPTIMA 500 SMALL HR DA	
HR: Cold water supply						
OPTIMA 500 ELECTRONIC 8 PROGRAMS						
	<p>RACK EQUIPMENT 1 X C40 1 X C44 1 X 15060</p> 	Multivoltage			OPTIMA 500	
		400 V 3N 50 Hz 6,65 kW	 340 H	600x610x850 H 65,5 kg	OPTIMA 500 DA	
		-- 230 V 3 50 Hz 6,65 kW	 Ø 340		 530x325x25 H	OPTIMA 500 HR
		230 V 50 Hz 6,65 kW	 500x500			OPTIMA 500 HR DA
HR: Cold water supply						

Model	Voltage	Capacity	Dimensions	Code
OPTIMA 500 H+	ELECTRONIC 10 PROGRAMS			
  <div data-bbox="352 533 528 728" style="border: 1px solid gray; padding: 5px; width: fit-content;"> RACK EQUIPMENT 1 X C40 1 X C44 1 X 15060 </div>	Multivoltage	 340 H	600x610x850 H 65,5 kg	OPTIMA 500 H+
	standard			 Ø 340
	400 V 3N 50 Hz 6,65 kW	 530x325x25 H	OPTIMA 500 HR H+	
	-- 230 V 3 50 Hz 6,65 kW		 500x500	OPTIMA 500 HR DA H+
	230 V 50 Hz 6,65 kW			
	--			
	HR: Cold water supply			

A₀=60 Special programs complying with A₀=60 on the scale of thermo-disinfection according to the norm EN ISO 15883-1. All our Hygiene+ models reach the A₀ 60 level defining the minimum reduction level of pathogenic microorganisms and bacterial load. In addition, our Plus Rinsing System guarantees a perfect rinse with steady temperature and water pressure for optimum hygienic results

X With special basket to be ordered

OPTIONS

Model	220-240 V 50 Hz		380-415 V 3N 50 Hz		220-240 V 3 50 Hz		60 Hz	RO	PS	DDE	ST	DBE
								Osmosis Connection	Drain Pump	Detergent Dispenser	Soft Start	Peristaltic Rinse-Aid Disp.
OPTIMA 400	●	M	M	€	□	●	●	●	●	●	●	●
OPTIMA 400 DA	●	M	M	€	----	●	●	●	●	●	●	●
OPTIMA 400 HR	●	M	M	€	□	●	●	●	●	●	●	●
OPTIMA 400 HR DA	●	M	M	€	----	●	●	●	●	●	●	●
OPTIMA 500 SMALL	M	●	M	€	□	●	●	●	●	●	●	●
OPTIMA 500 SMALL DA	M	●	M	€	----	●	●	●	●	●	●	●
OPTIMA 500 SMALL HR	M	●	M	€	□	●	●	●	●	●	●	●
OPTIMA 500 SMALL HR DA	M	●	M	€	----	●	●	●	●	●	●	●
OPTIMA 500	M	●	M	€	□	●	●	●	●	●	●	●
OPTIMA 500 DA	M	●	M	€	----	●	●	●	●	●	●	●
OPTIMA 500 HR	M	●	M	€	□	●	●	●	●	●	●	●
OPTIMA 500 HR DA	M	●	M	€	----	●	●	●	●	●	●	●
OPTIMA 500 H+	M	●	M	€	□	●	●	●	●	●	●	●
OPTIMA 500 DA H+	M	●	M	€	----	●	●	●	●	●	●	●
OPTIMA 500 HR H+	M	●	M	€	□	●	●	●	●	●	●	●
OPTIMA 500 HR DA H+	M	●	M	€	----	●	●	●	●	●	●	●

DA Built-in automatic water softener

HR In case of osmotic water supply, it is suggested to feed the machine with electrical conductivity of more than 200 microsiemens
In case of cold water supply for rinse (8-15 °C), the heat recovery option is mandatory

M Multivoltage

● Standard

---- Not available

□ Upon request

	FS	CR	TS	CONNECTIVITY	BT	WRAS	DVGW	PR	FLOAT
Model	Cold Rinse	Round Basket	Electr. timer + Thermostop	Connectivity (HACCP)	Break Tank	Wras	DVGW	Rinse pump	Probes lack det and rinse aid
OPTIMA 400	€	€	●	€	●	€	€	●	€
OPTIMA 400 DA	----	€	●	€	----	----	----	●	€
OPTIMA 400 HR	----	€	●	€	●	----	----	●	€
OPTIMA 400 HR DA	----	€	●	€	----	----	----	●	€
OPTIMA 500 SMALL	€	----	●	€	●	€	€	●	€
OPTIMA 500 SMALL DA	----	----	●	€	----	----	----	●	€
OPTIMA 500 SMALL HR	----	----	●	€	●	----	----	●	€
OPTIMA 500 SMALL HR DA	----	----	●	€	----	----	----	●	€
OPTIMA 500	€	----	●	€	●	€	€	●	€
OPTIMA 500 DA	----	----	●	€	----	----	----	●	€
OPTIMA 500 HR	----	----	●	€	●	----	----	●	€
OPTIMA 500 HR DA	----	----	●	€	----	----	----	●	€
OPTIMA 500 H+	€	----	●	€	●	€	€	●	€
OPTIMA 500 DA H+	----	----	●	€	----	----	----	●	€
OPTIMA 500 HR H+	----	----	●	€	●	----	----	●	€
OPTIMA 500 HR DA H+	----	----	●	€	----	----	----	●	€

SOFT START Progressive start of the wash pump

WRAS - DVGW Not available with FS

DVGW Components prescribed by DVGW on request (check option compatibility with the manufacturer)

CONNECTIVITY Includes HACCP option. 10-year plan

380-415 V 3N 50 HZ For the models OPTIMA 400 "upon request" provide extra power



220-240 V 3 50 HZ



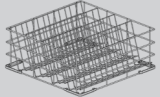
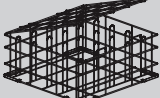

H+ (HYGIENE+) 2 cycles of 630 and 180 seconds with high temperatures, reaching up to 75 °C for washing and 90 °C for rinsing

Option compatibility to be confirmed by the manufacturer after verification

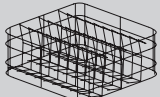
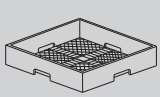
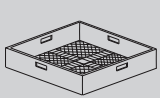
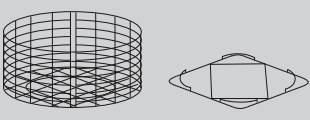
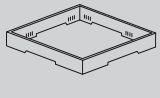
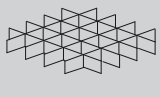
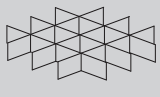
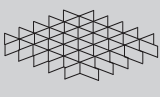
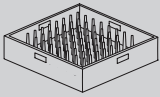
Water supply 55 °C (except HR versions)

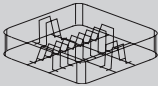
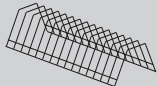
EAC label upon request

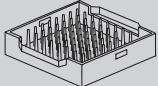
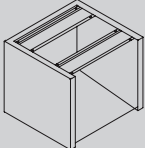
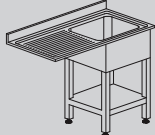
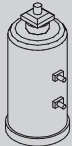
	Description	Capacity	Dimensions	Code	
	GLASS BASKET		400x400x135 H	C 121	
	SLOPED GLASS BASKET	Ø 100 max	500x500x200 H	C 26	
	REUSABLE CUP BASKET	5x5 glasses 30 mm < Ø < 90 mm H max 185 mm	500x500x235 H	C 135 	
	SLOPED GLASS BASKET	Ø 90 max	400x400x185 H	C 123	
		Ø 120 max	400x400x160 H	C 79	
	NARROW MESH CUTLERY BASKET		500x500x106 H	C 41	
	LARGE MESH BASKET	For glasses	500x500x105 H	C 44	
	ROUND GLASS BASKET	Basket	Ø 400x145 H	C 16	
	ROUND BASKET SUPPORT	Support	400x400	C 38	
	HOLDER FOR GLASS SUPPORT	For glass support (C112-C113-C114)	500x500x50 H	C 111	
	GLASS SUPPORT	5x5 Glass Ø 87 mm (C 111)	500x500x50 H	C 112	
	GLASS SUPPORT	4x4 Glass Ø 110 mm (C 111)	500x500x50 H	C 113	
	GLASS SUPPORT	6x6 Glass Ø 72 mm (C 111)	500x500x50 H	C 114	
	PLATE BASKET	18 Plates	500x500x105 H	C 40	

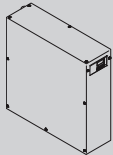
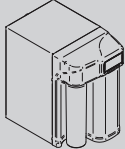
	Description	Capacity	Dimensions	Code	
	PLATE BASKET	12 Plates	400x400x120 H	C 31	
	SAUCER HOLDER	14 Saucers	300x100x90 H	10728	
	CUTLERY BASKET		Ø 120x120 H	15060	
	GASTRONORM TRAYS BASKET	6 pcs, max. depth 25 mm	500x500x105 H	C 43/B	
	STAND	Stainless steel stand	592x535x500 H	999900517	
	SINK UNIT FOR UNDER-COUNTER MODELS	Sink 500x400x300H	1200x700x850 H	A 20*	
	WATER SOFTENER	12 l	Ø 200x500 H	D 1	
	AUTOMATIC WATER SOFTENER	12 l (max 800 l)	315x510x685 H	D 2	
	OSMOSIS FOR OPTIMA 400 MODELS	230 V 50 Hz - 250 W 5° C - 30° C Flow rate 180-210l/h - 15°C Not suitable for machine with integrated water softener Special basket dotation	145x560x580 H 25 Kg	OS 180	
	OSMOSIS FOR OPTIMA 500 MODELS	230 V 50 Hz - 250 W 5° C - 30° C Flow rate 240 l/h Not suitable for machine with integrated water softener Special basket dotation	270x411x451 H 18 Kg	OS 240	

* Wooden cage +2% minimum + €

Special dimensions for tables upon request

Tables shown in right-to-left version

HT 10

ROBUST AND ESSENTIAL
HOOD-TYPE DISHWASHERS



You asked and we listened! We are thrilled to announce our brand new range: HT 10. These robust and essential hood-type dishwashers simply make sense. Nothing superfluous: solid S/S

body with single skin hood, sloped tank, innovative and light arms, controlled temperatures and, only if needed, detergent dispenser and drain pump. Wash, rinse, restart. It is really that simple.









ELECTRONIC VERSION

The intuitive LED control panel of the HT 10 L model will display if the correct temperatures of both tank and boiler have been reached. You can choose among 3 different wash programs to perfectly tailor the performances of the machine to the crockery that needs to be cleaned.

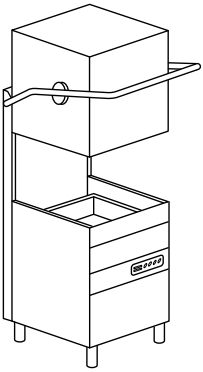





FEATURES

- 1 wash cycle (HT 10)
- 3 wash cycles (HT 10 L)
- Self-cleaning cycle on the electronic version (HT 10 L)
- Tank and boiler thermometers
- Hood operating start/stop functions
- Deep-formed tank
- Innovative system of coupled wash and rinse arms in polypropylene and fiber of glass
- Standard surface filters in polypropylene
- Pump filter
- Standard rinse aid dispenser
- Easily removable basket support
- Linear or corner layouts

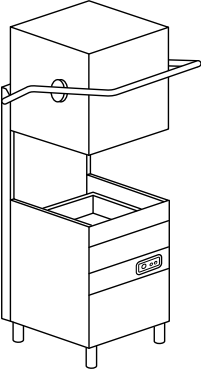
ROBUST AND ESSENTIAL
HOOD-TYPE DISHWASHERS

Model	Voltage	Capacity	Dimensions	Code
<p>HT 10</p> 	<p>1 PROGRAM</p> <p>new</p> <div style="border: 1px solid black; padding: 5px; width: fit-content;"> <p>RACK EQUIPMENT</p> <p>1 X C40</p> <p>1 X C44</p> <p>1 X 15060</p> </div> 	<p>400 V 3N ~ 50 Hz 6,55 kW</p>	<p>355 H</p>  <p>720x735x 1445/1880 H 100 kg</p>  <p>Ø 410</p>  <p>500x500</p> <p>GN 1/1 </p> <p>530x325x25 H</p>	<p>HT 10</p>

X With special basket to be ordered

Model		Voltage	Capacity	Dimensions	Code
HT 10 L	3 PROGRAMS New				
	RACK EQUIPMENT 1 X C40 1 X C44 1 X 15060 	400 V 3N ~ 50 Hz 6,55 kW	 355 H  Ø 410  500x500	720x735x 1445/1880 H 100 kg  530x325x25 H	HT 10 L

HT 10

ROBUST AND ESSENTIAL
HOOD-TYPE DISHWASHERS





OPTIONS

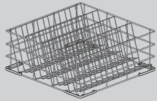
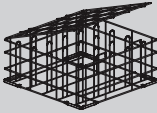

		PS	DDE	DB	TS	DF
Model	380-415 V 3N 50 Hz	Drain Pump	Detergent Dispenser	Rinse-Aid Dispenser	Electr. Timer +Thermostop	Surface Filters
HT 10	●	€	€	●	●	●
HT 10 L	●	€	€	●	●	●

- Standard
- Not available
- L** LED electronic

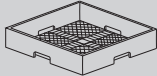
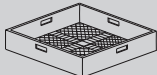
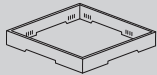
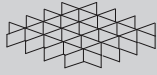
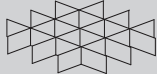
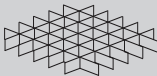
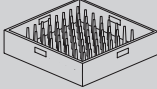
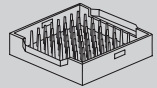
EAC label upon request

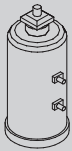
Water supply 55 °C

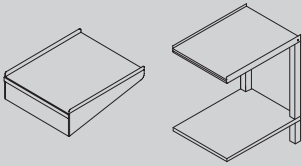
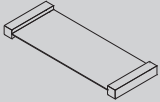
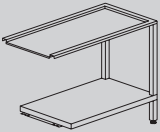
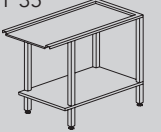
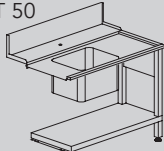
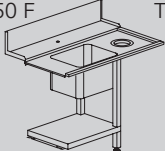
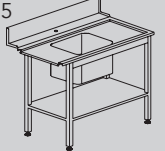
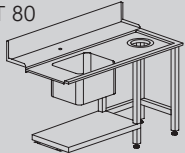
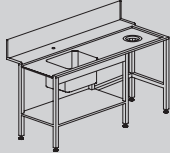
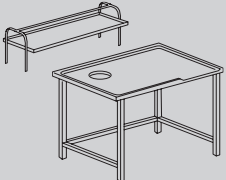
	Description	Capacity	Dimensions	Code	
	SLOPED GLASS BASKET	Ø 100 max	500x500x200 H	C 26	
	REUSABLE CUP BASKET	5x5 glasses 30 mm < Ø < 90 mm H max 185 mm	500x500x235 H	C 135 	
	NARROW MESH CUTLERY BASKET		500x500x106 H	C 41	
	LARGE MESH BASKET	For glasses	500x500x105 H	C 44	
	HOLDER FOR GLASS SUPPORT	For glass support (C112-C113-C114)	500x500x50 H	C 111	
	GLASS SUPPORT	5x5 Glass Ø 87 mm (C111)	500x500x50 H	C 112	
	GLASS SUPPORT	4x4 Glass Ø 110 mm (C111)	500x500x50 H	C 113	
	GLASS SUPPORT	6x6 Glass Ø 72 mm (C111)	500x500x50 H	C 114	
	PLATE BASKET	18 Plates	500x500x105 H	C 40	
	GASTRONORM TRAYS BASKET	6 pcs max depth 25mm	500x500x105 H	C 43/B	
	CUTLERY BASKET	Standard (2 pcs)	Ø 120x120 H	15060	
	WATER SOFTENER	12 l	Ø 200x500 H	D 1	

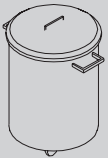
	Description	Capacity	Dimensions	Code	
	AUTOMATIC WATER SOFTENER	12 l (max 800 l)	315x510x685 H	D 2	
	SHELF	Only for exit	600x510	T 10	
	TABLE		650x510x860 H	T 28	
	HOOD CONNECTION SHELF			KIT DUO	
T 34 A T 34 B 	T 35 	Table	700x590x860 H 1200x590x860 H 1200x590x860 H	T 34 A T 34 B T 35	
T 50 	T 50 F 	T 55 	Sink 500x400x270 H	1200x730x860 H 1200x730x860 H 1200x730x860 H	T 50 T 50 F T 55
T 80 	T 80 E T 90 	Sink 500x400x270 H	1500x730x860 H 1500x730x860 H 1800x730x860 H	T 80 T 80 E T 90	
	SHELF		1515x620x660 H 2315x620x660 H	M 16* M 24*	
	GRADING TABLE WITH RUBBER RING	Waste hole and special dimensions upon request	1600x1000x850 H 2400x1000x850 H	TC 16* TC 24*	
	FLEXIBLE SHOWER complete with mixing group and lever tap, to be fixed to the wall		1000 H	D 01	
	FLEXIBLE SHOWER complete with mixing group and lever tap, to be fixed to the wall and intermediate tap		1000 H	D 02	
	STAINLESS STEEL WASTE BIN	Basic model With wheels With wheels and pedal board	Ø 400x570 H Ø 400x570 H Ø 400x570 H	P 01 P 02 P 03	

* Wooden cage +2% minimum + €

Special dimensions for tables upon request

Tables shown in right-to-left version



The DIHR hood-type dishwashers offer a wide range of models, from the ones that can be equipped with the most advanced options, to the most innovative types, designed with avant-garde electronics and with all options included. Our products have evolved together with our experience and our customers' hints and insights.

Therefore we are able to produce tailor-made models that fulfil our final customers' criteria of functionality, reliability and versatility. Our aim is to reduce consumptions in terms of energy, water and chemical products, therefore granting the final user global savings, but also less pollution and waste of natural resources.



TOUCH PANEL

The LED panel displays the temperatures of both tank and boiler, the wash cycle and status and eventual main alarm codes for malfunctions. There are four wash cycles available. These innovations are designed to provide DIHR's customers with even more user friendly machines, maintaining the same high performances. The soft start function grants extra protection for fragile objects.

FEATURES HT 11 ECO / HT 11







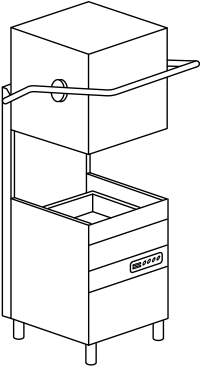

- Two wash cycles
- Hood operating start/stop functions
- Tank deep-formed bottom
- Pump filter
- Built-in rinse-aid pump
- Tank and boiler thermometres
- Easily removable basket support
- Linear or corner layouts
- Innovative system of coupled wash and rinse arms in polypropylene and fiber of glass (HT 11 ECO)
- Independent stainless steel wash arms and polypropylene and fiber of glass rinse arms (HT 11)
- Surface filters in polypropylene (HT 11 ECO)
- S/S surface filters (HT 11)
- Built-in water softener available (HT 11)

FEATURES HT 11 ECO T / HT 11 T



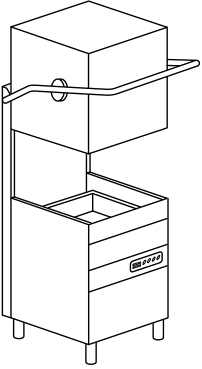



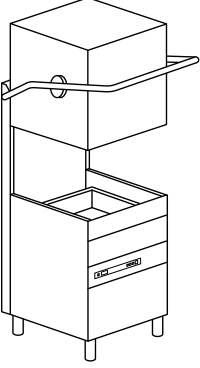

- Easy and intuitive LED control panel
- Four wash cycles
- Hood operating start/stop functions
- Tank deep-formed bottom
- Built-in rinse-aid pump
- Tank and boiler thermometres
- Surface filters
- Easily removable basket support
- Linear or corner layouts
- Self-cleaning cycle
- Innovative system of coupled wash and rinse arms in polypropylene and fiber of glass (HT 11 ECO T)
- Independent stainless steel wash arms and polypropylene and fiber of glass rinse arms (HT 11 T)
- Surface filters in polypropylene (HT 11 ECO T)
- S/S surface filters (HT 11 T)
- Automatic built-in water softener available (HT 11 T)

HT 11

SINGLE SKIN HOOD-TYPE
DISHWASHERS

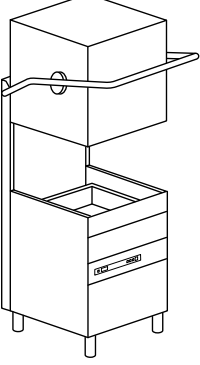
Model		Voltage	Capacity	Dimensions	Code
HT 11 ECO	2 PROGRAMS				
	<p>RACK EQUIPMENT</p> <ul style="list-style-type: none"> 2 X C40 1 X C44 2 X 15060 	400 V 3N ~ 50 Hz 6,9 kW	 Ø 410  500x500	720x735x 1445/1880 H 100 kg  530x325x25 H	HT 11 ECO
HT 11	2 PROGRAMS				
	<p>RACK EQUIPMENT</p> <ul style="list-style-type: none"> 2 X C40 1 X C44 2 X 15060 	400 V 3N ~ 50 Hz 10,2 kW	 Ø 410  500x500	720x735x 1445/1880 H 100 kg  530x325x25 H	HT 11 HT 11 D

X With special basket to be ordered

Model	Voltage	Capacity	Dimensions	Code
HT 11 ECO T 	ELECTRONIC 4 PROGRAMS 400 V 3N ~ 50 Hz 6,9 kW	 Ø 410  500x500	720x735x 1445/1880 H 100 kg  530x325x25 H	HT 11 ECO T HT 11 ECO T DA
HT 11 T 	ELECTRONIC 4 PROGRAMS 400 V 3N ~ 50 Hz 10,2 kW	 Ø 410  500x500	720x735x 1445/1880 H 100 kg  530x325x25 H	HT 11 T HT 11 T DA

OPTIONS

Model							XP	PS	DDE
	220-240 V 50 Hz	380-415 V 3N 50 Hz	220-240 V 3 50 Hz	380-415 V 3 50 Hz	440 V 3 60 Hz	60 Hz	Extra Power	Drain Pump	Detergent Dispenser
HT 11 ECO	€	●	□	----	----	€	€	€	€
HT 11 *	€	●	□	----	----	€	€	€	€
HT 11 D	€	●	□	----	----	€	€	€	€
HT 11 ECO T	€	●	□	----	----	€	€	€	€
HT 11 ECO T DA	€	●	□	----	----	€	€	€	€
HT 11 T	€	●	□	----	----	€	€	€	€
HT 11 T DA	€	●	□	----	----	€	€	€	€

- Standard
- Upon request
- Not available
- D** Built-in water softener
- DA** Built-in automatic water softener
- T** LED electronic (SOFT TOUCH)
- * Construction according to UL-NSF standards upon request

EAC label upon request

Water supply 55 °C

	DB	DBE	TS	ST	BT	WRAS	DVGW	PAP	DF
Model	Rinse-Aid Dispenser	Peristaltic Rinse-Aid Disp.	Electr. Timer +Thermostop	Soft Start	Break Tank	Wras	DVGW	Booster Pump	Surface Filters Kit
HT 11 ECO	●	€	●	----	€	€	€	€	●
HT 11 *	●	€	●	----	€	€	€	€	●
HT 11 D	●	€	●	----	----	----	----	€	●
HT 11 ECO T	●	€	●	●	€	€	€	€	●
HT 11 ECO T DA	●	€	●	●	----	----	----	€	●
HT 11 T	●	€	●	●	€	€	€	€	●
HT 11 T DA	●	€	●	●	----	----	----	€	●

SOFT START Progressive start of the wash pump







230-240 V 50 HZ For HT 11 total power 7,2 kW upon request

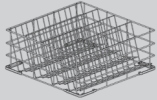
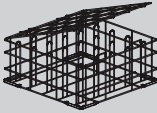

XP In case of cold water supply for rinse (8-55 °C) and without any heat recovery, the extra power option is mandatory. +3000 W with standard voltage only, for other voltages please contact us. In case of cold water supply for rinse (8-15 °C), We recommend the heat recovery option, if available on the selected model

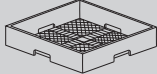
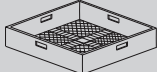
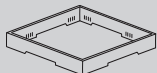
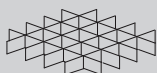
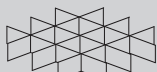
BT - WRAS - DVGW Booster pump included.

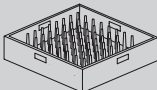
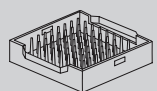
DVGW Components prescribed by DVGW on request (check option compatibility with the manufacturer)

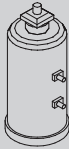
Option compatibility to be confirmed by the manufacturer after verification.

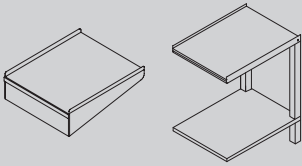
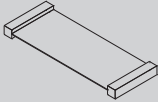
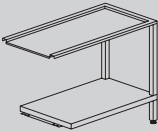
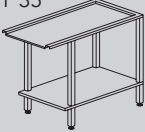
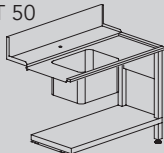
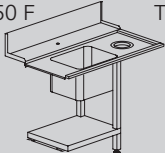
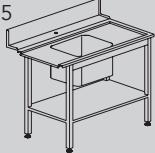
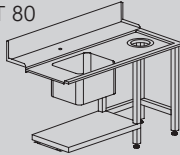
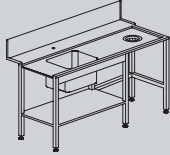
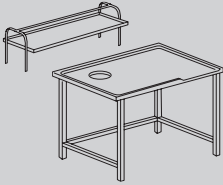
	Description	Capacity	Dimensions	Code	
	SLOPED GLASS BASKET	Ø 100 max	500x500x200 H	C 26	
	REUSABLE CUP BASKET	5x5 glasses 30 mm < Ø < 90 mm H max 185 mm	500x500x235 H	C 135 	
	NARROW MESH CUTLERY BASKET		500x500x106 H	C 41	
	LARGE MESH BASKET	For glasses	500x500x105 H	C 44	
	HOLDER FOR GLASS SUPPORT	For glass support (C112-C113-C114)	500x500x50 H	C111	
	GLASS SUPPORT	5x5 Glass Ø 87 mm (C 111)	500x500x50 H	C 112	
	GLASS SUPPORT	4x4 Glass Ø 110 mm (C 111)	500x500x50 H	C 113	
	GLASS SUPPORT	6x6 Glass Ø 72 mm (C 111)	500x500x50 H	C 114	
	PLATE BASKET	18 Plates	500x500x105 H	C 40	
	GASTRONORM TRAYS BASKET	6 pcs max depth 25mm	500x500x105 H	C 43/B	
	CUTLERY BASKET	Standard (2 pcs)	Ø 120x120 H	15060	
	WATER SOFTENER	12 l	Ø 200x500 H	D 1	

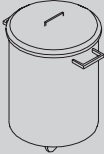
	Description	Capacity	Dimensions	Code				
	AUTOMATIC WATER SOFTENER	12 l (max 800 l)	315x510x685 H	D 2				
	SHELF	Only for exit	600x510	T 10				
	TABLE		650x510x860 H	T 28				
	HOOD CONNECTION SHELF			KIT DUO				
T 34 A T 34 B		T 35		Table	700x590x860 H 1200x590x860 H 1200x590x860 H	T 34 A T 34 B T 35		
T 50		T 50 F		T 55		Sink 500x400x270 H	1200x730x860 H 1200x730x860 H 1200x730x860 H	T 50 T 50 F T 55
T 80		T 80 E T 90				Sink 500x400x270 H	1500x730x860 H 1500x730x860 H 1800x730x860 H	T 80 T 80 E T 90
	SHELF		1515x620x660 H 2315x620x660 H	M 16* M 24*				
	GRADING TABLE WITH RUBBER RING	Waste hole and special dimensions upon request	1600x1000x850 H 2400x1000x850 H	TC 16* TC 24*				
	FLEXIBLE SHOWER complete with mixing group and lever tap, to be fixed to the wall		1000 H	D 01				
	FLEXIBLE SHOWER complete with mixing group and lever tap, to be fixed to the wall and intermediate tap		1000 H	D 02				
	STAINLESS STEEL WASTE BIN	Basic model	Ø 400x570 H	P 01				
		With wheels	Ø 400x570 H	P 02				
		With wheels and pedal board	Ø 400x570 H	P 03				

* Wooden cage +2% minimum + €

Special dimensions for tables upon request

Tables shown in right-to-left version



The DIHR hood-type dishwashers offer a wide range of models, from the ones that can be equipped with the most advanced options, to the most innovative types, designed with avant-garde electronics and with all options included. Our products have evolved together with our experience and our customers' hints and insights.

Therefore we are able to produce tailor-made models that fulfil our final customers' criteria of functionality, reliability and versatility. Our aim is to reduce consumptions in terms of energy, water and chemical products, therefore granting the final user global savings, but also less pollution and waste of natural resources.



TOUCH PANEL

The LED panel displays the temperatures of both tank and boiler, the wash cycle and status and eventual main alarm codes for malfunctions. There are four wash cycles available. These innovations are designed to provide PLATINUM's customers with even more user friendly machines, maintaining the same high performances. The "Soft Start" function grants extra protection for fragile objects.

FEATURES HT 11 I





- Two wash cycles
- Hood operating start/stop functions
- Tank deep-formed bottom
- Pump filter
- S/S surface filters
- Double skin insulated hood
- Built-in rinse-aid pump
- Tank and boiler thermometres
- Easily removable basket support
- Linear or corner layouts
- Independent stainless steel wash arms and polypropylene and fiber of glass rinse arms
- Built-in water softener available

FEATURES HT 11 I T



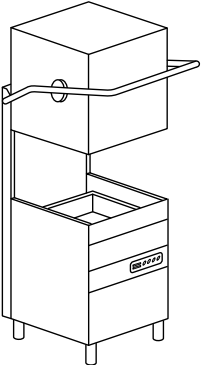

- Easy and intuitive LED control panel
- Four wash cycles
- Hood operating start/stop functions
- Tank deep-formed bottom
- Built-in rinse-aid pump
- Tank and boiler thermometres
- Surface filters
- Easily removable basket support
- Double skin insulated hood
- Linear or corner layouts
- Independent stainless steel wash arms and polypropylene and fiber of glass rinse arms
- Self-cleaning cycle
- Automatic built-in water softener available

HT 11 I

INSULATED
HOOD-TYPE DISHWASHERS

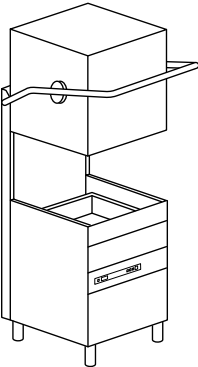
Model		Voltage	Capacity	Dimensions	Code
HT 11 I	2 PROGRAMS				
	<div style="border: 1px solid black; padding: 5px; width: fit-content;"> <p>RACK EQUIPMENT</p> <p>2 X C40 1 X C44 2 X 15060</p> </div> 	<p>400 V 3N ~ 50 Hz 10,2 kW</p>	 <p>ø 410</p>  <p>500x500</p>	<p>720x735x 1445/1880 H 100 kg</p>	HT 11 I
				 <p>GN 1/1</p>	<p>530x325x25 H</p>

X With special basket to be ordered

Model	Voltage	Capacity	Dimensions	Code
HT 11 I T 	ELECTRONIC 4 PROGRAMS RACK EQUIPMENT 2 X C40 1 X C44 2 X 15060 	400 V 3N ~ 50 Hz 10,2 kW  ø 410  500x500	720x735x 1445/1880 H 100 kg  530x325x25 H	HT 11 I T HT 11 I T DA

OPTIONS

							XP	PS	DDE	DB
Model	220-240 V 50 Hz	380-415 V 3N 50 Hz	220-240 V 3 50 Hz	380-415 V 3 50 Hz	440 V 3 60 Hz	60 Hz	Extra Power	Drain Pump	Detergent Dispenser	Rinse-Aid Dispenser
HT 11 I	€	●	□	----	----	€	€	€	€	●
HT 11 I D	€	●	□	----	----	€	€	€	€	●
HT 11 I T	€	●	□	----	----	€	€	€	€	●
HT 11 I T DA	€	●	□	----	----	€	€	€	€	●

● Standard

□ Upon request

---- Not available

I Insulated hood

D Built-in water softener

DA Built-in automatic water softener

T LED electronic (SOFT TOUCH)

EAC label upon request

Water supply 55 °C

	DBE	TS	ST	BT	WRAS	DVGW	PAP	ID	DF
Model	Peristaltic Rinse-Aid Disp.	Electr. Timer +Thermo-stop	Soft Start	Break Tank	Wras	DVGW	Booster Pump	Double Skin	Surface Filters Kit
HT 11 I	€	●	----	€	€	€	€	●	●
HT 11 I D	€	●	----	----	----	----	€	●	●
HT 11 I T	€	●	●	€	€	€	€	●	●
HT 11 I T DA	€	●	●	----	----	----	€	●	●





230-240 V 50 HZ For HT 11 total power 7,2 kW upon request

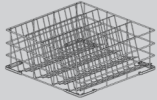
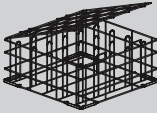

XP In case of cold water supply for rinse (8-55 °C) and without any heat recovery, the extra power option is mandatory. +3000 W with standard voltage only, for other voltages please contact us. In case of cold water supply for rinse (8-15 °C). We recommend the heat recovery option, if available on the selected model.

BT - WRAS - DVGW Booster pump included.

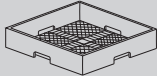
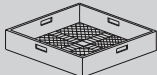
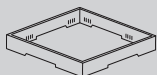
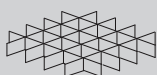
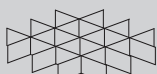
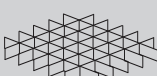
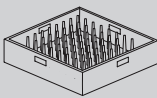
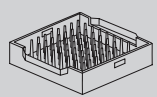
DVGW Components prescribed by DVGW on request (check option compatibility with the manufacturer)

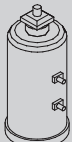
Option compatibility to be confirmed by the manufacturer after verification.

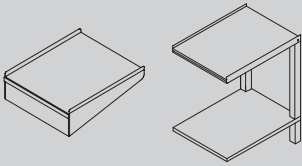
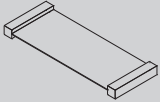
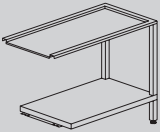
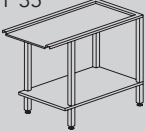
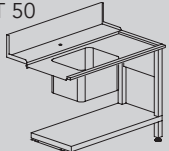
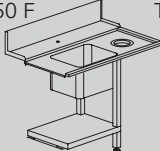
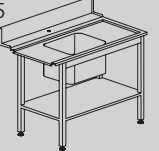
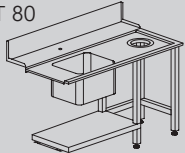
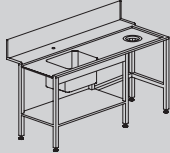
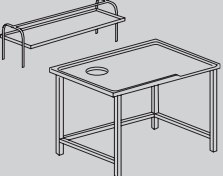
	Description	Capacity	Dimensions	Code	
	SLOPED GLASS BASKET	Ø 100 max	500x500x200 H	C 26	
	REUSABLE CUP BASKET	5x5 glasses 30 mm < Ø < 90 mm H max 185 mm	500x500x235 H	C 135 	
	NARROW MESH CUTLERY BASKET		500x500x106 H	C 41	
	LARGE MESH BASKET	For glasses	500x500x105 H	C 44	
	HOLDER FOR GLASS SUPPORT	For glass support (C112-C113-C114)	500x500x50 H	C111	
	GLASS SUPPORT	5x5 Glass Ø 87 mm (C 111)	500x500x50 H	C 112	
	GLASS SUPPORT	4x4 Glass Ø 110 mm (C 111)	500x500x50 H	C 113	
	GLASS SUPPORT	6x6 Glass Ø 72 mm (C 111)	500x500x50 H	C 114	
	PLATE BASKET	18 Plates	500x500x105 H	C 40	
	GASTRONORM TRAYS BASKET	6 pcs max depth 25mm	500x500x105 H	C 43/B	
	CUTLERY BASKET	Standard (2 pcs)	Ø 120x120 H	15060	
	WATER SOFTENER	12 l	Ø 200x500 H	D 1	

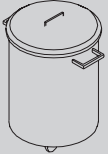
	Description	Capacity	Dimensions	Code	
	AUTOMATIC WATER SOFTENER	12 l (max 800 l)	315x510x685 H	D 2	
	SHELF	Only for exit	600x510	T 10	
	TABLE		650x510x860 H	T 28	
	HOOD CONNECTION SHELF			KIT DUO	
T 34 A T 34 B		T 35		Table	700x590x860 H T 34 A 1200x590x860 H T 34 B 1200x590x860 H T 35
T 50		T 50 F		T 55	 Sink 500x400x270 H 1200x730x860 H T 50 1200x730x860 H T 50 F 1200x730x860 H T 55
T 80		T 80 E T 90		Sink 500x400x270 H	1500x730x860 H T 80 1500x730x860 H T 80 E 1800x730x860 H T 90
	SHELF		1515x620x660 H 2315x620x660 H	M 16* M 24*	
	GRADING TABLE WITH RUBBER RING	Waste hole and special dimensions upon request	1600x1000x850 H 2400x1000x850 H	TC 16* TC 24*	
	FLEXIBLE SHOWER complete with mixing group and lever tap, to be fixed to the wall		1000 H	D 01	
	FLEXIBLE SHOWER complete with mixing group and lever tap, to be fixed to the wall and intermediate tap		1000 H	D 02	
	STAINLESS STEEL WASTE BIN	Basic model	Ø 400x570 H	P 01	
		With wheels	Ø 400x570 H	P 02	
		With wheels and pedal board	Ø 400x570 H	P 03	

* Wooden cage +2% minimum + €

Special dimensions for tables upon request

Tables shown in right-to-left version

HT 12 ELECTRON

LATEST GENERATION
HOOD-TYPE DISHWASHERS



The latest generation DIHR hoodtype dishwashers. These machines are built with fully double-skin hoodtype, designed for being silent and reliable. Beside the standard electronic versions with four programmable cycles, we have developed the PLUS models with guaranteed steady rinse temperature and pressure and two cycles with

HYGIENE+ superior features ($A_0=30$ on the scale of thermo-disinfection according to the norm EN ISO 15883-1). Thanks to these latest technological features, the sturdy PLUS versions will promote the almost total elimination of the bacterial load. The customization of our new generation machines has never been so easy!

$A_0=30$
HYGIENE+

HYGIENE+ SYSTEM

The HYGIENE+ models perform long cycles at high temperatures to fulfill high levels of hygiene, now more essential than ever for our health. These special programs comply with $A_0=30$ on the scale of thermo-disinfection according to the norm EN ISO 15883-1.

The HYGIENE+ models include 2 special cycles, a short one of 180 seconds and a longer one of 630 seconds, ensuring compliance with high levels of hygiene thanks to high temperatures and long cycles.



FEATURES

- Easy and intuitive electronic control panel
- Modification of the dosage of detergent and rinse-aid directly on the control panel (PLUS versions)
- Remote control panel available on request instead of the standard control panel (PLUS versions)
- Four customizable programs
- HYGIENE+ version (H+ models): two special additional programs complying with $A_0=30$ according to the norm EN ISO 15883-1
- Double skin insulated hood
- Deep tank
- Double tank filters, with dirt collection system and pump filter (improved system for a better filtration of the wash water)
- Self-cleaning vertical pump
- Rinse-aid and detergent dispensers included (peristaltic rinse-aid dispenser included on PLUS versions)
- Water consumption and working time control system (PLUS versions)
- Easy to access for maintenance
- Anti-drop roof panel
- Easily removable basket support
- Linear or corner layouts
- Self-cleaning cycle
- Built-in peristaltic detergent dispenser and built-in rinse-aid dispenser (peristaltic rinse-aid dispenser included in the PLUS versions)
- The PLUS system grants a constant rinse temperature and pressure (PLUS models)
- LIFT: automatic hood lift at the end of cycle
- HR: ENERGY RECOVERY system (HT 12 ELECTRON PLUS HR H+)
- CONNECTIVITY remote control compliant with the HACCP norms (on request)
- Predisposition for connection to an external device of reverse osmosis (on request on PLUS versions)

CONNECTIVITY 4.0 & APP

WHEREVER YOU ARE...
YOUR DISHWASHER, JUST A CLICK AWAY

You will be constantly connected to the machine to monitor the work phases, review any eventual alarm and configure remotely the operating parameters according to your needs. Compliant with HACCP norms. Thanks to our brand new App, you will have access to connected machines and all commercial and technical documentation.

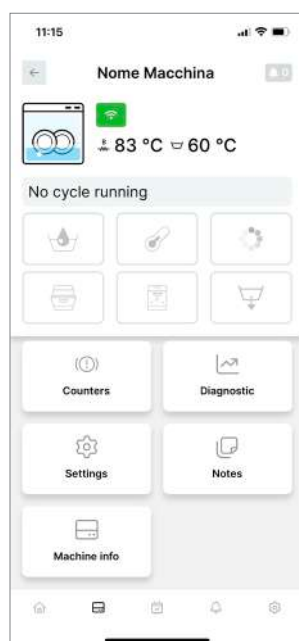

View all the working parameters and event records, working hours and any problem at any time.



In case of problem, the machine promptly alerts you. The technician can intervene remotely to solve the problem or anticipate the needed parts for an on-site intervention.



A daily activity report is available with all the events related to the dishwasher in a detailed spreadsheet with HACCP data.



Our Connectivity system is a revolutionary device limiting and facilitating the eventual intervention of a technician who can anticipate the necessary parts to be replaced, saving time and money.

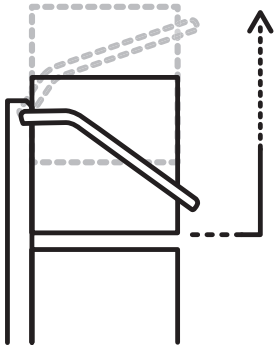

IMPROVED LIFT SYSTEM:

AUTOMATIC TWO-STEP HOOD LIFT AT THE END OF THE CYCLE

The hydraulic system has been replaced by an electric motor. Its simplicity limits maintenance and the formation of limescale. The latter, freeing up space, allows to add more options to the LIFT models such as the integrated automatic softener.

PLUS SYSTEM

GUARANTEED RINSE EVEN WITH LOW PRESSURE OF THE WATER INLET

We have developed an innovative rinsing system at constant temperature, consumption and water pressure, regardless of external conditions.

ATMOSPHERIC BOILER

The water temperature in the boiler remains constant at 85°C throughout the rinse, as the boiler refill only occurs once the rinse cycle is done.

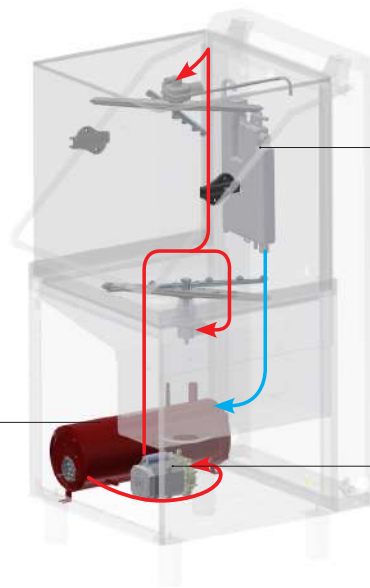

BREAK TANK

The Break Tank system prevents the heated water of the boiler to go back and mix with the fresh water supply.

RINSE PUMP

The water is sucked from the boiler through a rinse pump and is sent to the rinse nozzles. The correct pressure is ensured regardless of the water inlet pressure and temperature.





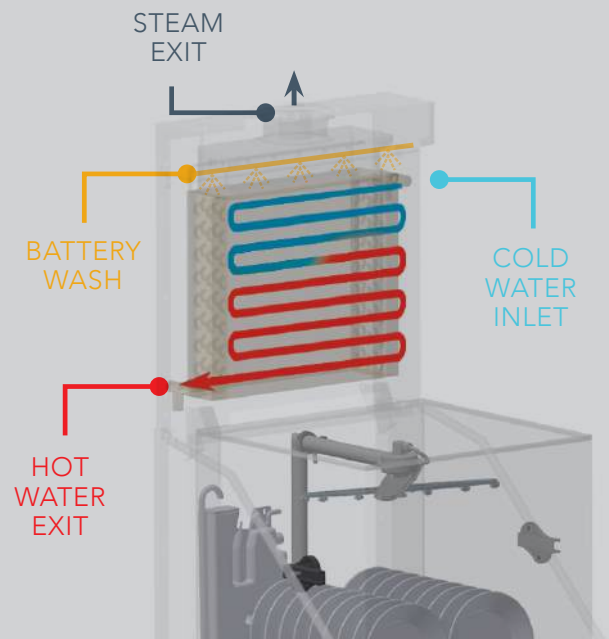





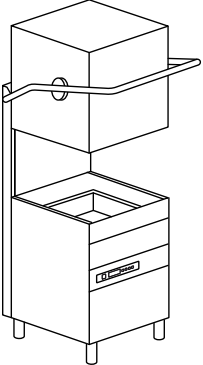



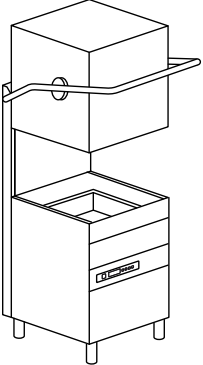

HR - ENERGY RECOVERY

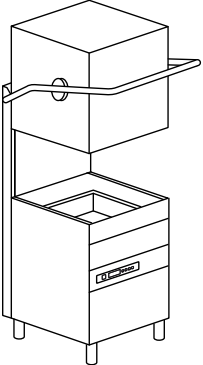
The ENERGY RECOVERY system uses the heat produced by the machine to preheat the inlet cold water (8-15 °C). This is an immediate saving on energy costs. Additionally, an optimal temperature in the dishwashing area is achieved as the air is no more affected by steam and humidity.

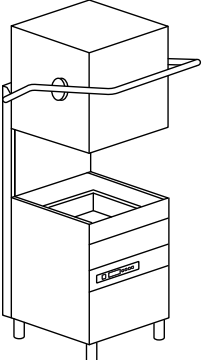

HT 12 ELECTRON

LATEST GENERATION
HOOD-TYPE DISHWASHERS

Model	Voltage	Capacity	Dimensions	Code
HT 12 ELECTRON ELECTRONIC 4 PROGRAMS				
 <p>RACK EQUIPMENT 2 X C40 1 X C44 2 X 15060</p>	400 V 3N ~ 50 Hz 10,5 kW	 ø 410  500x500	720x735x 1445/1880 H 115 kg  530x325x25 H	HT 12 ELECTRON HT 12 ELECTRON DA
HT 12 ELECTRON H+ ELECTRONIC 4 PROGRAMS				
 <p>RACK EQUIPMENT 2 X C40 1 X C44 2 X 15060</p>	400 V 3N ~ 50 Hz 10,5 kW	 ø 410  500x500	720x735x 1445/1880 H 115 kg  530x325x25 H	HT 12 ELECTRON H+ HT 12 ELECTRON DA H+
HT 12 ELECTRON LIFT ELECTRONIC 4 PROGRAMS				
 <p>RACK EQUIPMENT 2 X C40 1 X C44 2 X 15060</p>	400 V 3N ~ 50 Hz 10,5 kW	 ø 410  500x500	720x735x 1445/1880 H 119 kg  530x325x25 H	HT 12 ELECTRON LIFT HT 12 ELECTRON LIFT DA
HT 12 ELECTRON LIFT H+ ELECTRONIC 4 PROGRAMS				
 <p>RACK EQUIPMENT 2 X C40 1 X C44 2 X 15060</p>	400 V 3N ~ 50 Hz 10,5 kW	 ø 410  500x500	720x735x 1445/1880 H 119 kg  530x325x25 H	HT 12 ELECTRON LIFT H+ HT 12 ELECTRON LIFT DA H+

Model	Voltage	Capacity	Dimensions	Code
HT 12 ELECTRON PLUS H+	ELECTRONIC 6 PROGRAMS			

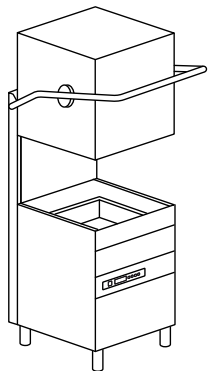

RACK EQUIPMENT
2 X C40
1 X C44
2 X 15060

A₂=30
HYGIENE +

400 V 3N ~ 50 Hz
10,5 kW



720x735x
1445/1880 H
115 kg

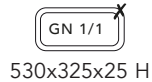

HT 12 ELECTRON PLUS H+

HT 12 ELECTRON PLUS DA H+

HT 12 ELECTRON PLUS HR H+	ELECTRONIC 6 PROGRAMS - HR: HEAT RECOVERY			
----------------------------------	---	--	--	--

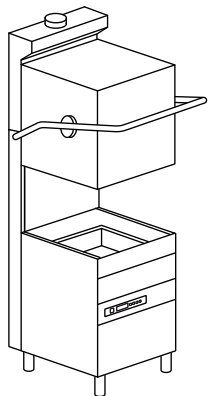

RACK EQUIPMENT
2 X C40
1 X C44
2 X 15060

A₂=30
HYGIENE +

400 V 3N ~ 50 Hz
10,5 kW

HR: cold water supply



720x735x
2095 H
145 kg

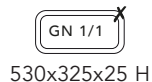

HT 12 ELECTRON PLUS HR H+

HT 12 ELECTRON PLUS HR DA H+

HT 12 ELECTRON PLUS LIFT H+	ELECTRONIC 6 PROGRAMS			
------------------------------------	-----------------------	--	--	--

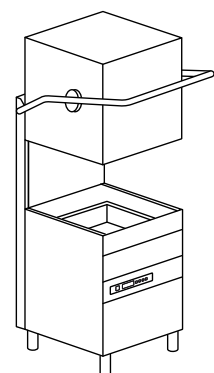

RACK EQUIPMENT
2 X C40
1 X C44
2 X 15060

A₂=30
HYGIENE +

400 V 3N ~ 50 Hz
10,5 kW



720x735x
1445/1880 H
145 kg

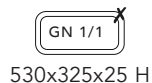

HT 12 ELECTRON PLUS LIFT H+

HT 12 ELECTRON PLUS LIFT DA H+

HT 12 ELECTRON PLUS HR LIFT H+	ELECTRONIC 6 PROGRAMS - HR: HEAT RECOVERY			
---------------------------------------	---	--	--	--

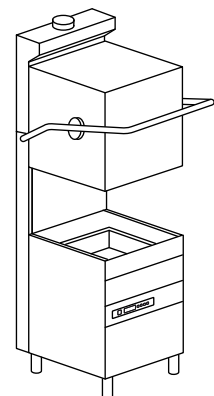

RACK EQUIPMENT
2 X C40
1 X C44
2 X 15060

A₂=30
HYGIENE +

400 V 3N ~ 50 Hz
10,5 kW

HR: cold water supply



720x735x
2095 H
145 kg



HT 12 ELECTRON PLUS HR LIFT H+

HT 12 ELECTRON PLUS HR LIFT DA H+

HT 12 ELECTRON

LATEST GENERATION
HOOD-TYPE DISHWASHERS

OPTIONS

	380-415 V 3N 50 Hz	220-240 V 3 50 Hz	380-415 V 3 50 Hz	440 V 3 60 Hz	60 Hz	RO Osmosis Connection	XP Extra Power	PS Drain Pump	DDE Detergent Dispenser	DB Rinse-Aid Dispenser
HT 12 ELECTRON	●	□	€	€	€	----	€	€	●	●
HT 12 ELECTRON DA	●	□	€	€	€	----	€	€	●	●
HT 12 ELECTRON H+	●	□	€	€	€	----	€	€	●	●
HT 12 ELECTRON DA H+	●	□	€	€	€	----	€	€	●	●
HT 12 ELECTRON LIFT	●	□	€	€	€	----	€	€	●	●
HT 12 ELECTRON LIFT DA	●	□	€	€	€	----	€	€	●	●
HT 12 ELECTRON LIFT H+	●	□	€	€	€	----	€	€	●	●
HT 12 ELECTRON LIFT DA H+	●	□	€	€	€	----	€	€	●	●
HT 12 ELECTRON PLUS H+	●	□	€	€	€	□	€	€	●	----
HT 12 ELECTRON PLUS DA H+	●	□	€	€	€	----	€	€	●	----
HT 12 ELECTRON PLUS HR H+	●	□	€	€	€	□	€	€	●	----
HT 12 ELECTRON PLUS HR DA H+	●	□	€	€	€	----	€	€	●	----
HT 12 ELECTRON PLUS LIFT H+	●	□	€	€	€	□	€	€	●	----
HT 12 ELECTRON PLUS LIFT DA H+	●	□	€	€	€	----	€	€	●	----
HT 12 ELECTRON PLUS HR LIFT H+	●	□	€	€	€	□	€	€	●	----
HT 12 ELECTRON PLUS HR LIFT DA H+	●	□	€	€	€	----	€	€	●	----

● Standard

□ Upon request

---- Not available

DA Built-in automatic water softener

PS Not available in 400 V 3 50 Hz on the PLUS versions

HR Available in case of osmotic water supply, if the electrical conductivity is higher than 200 microsiemens

LIFT Automatic two-step hood lift at the end of the cycle

PLUS Rinse with constant temperature and stabilized consumption

H+ 2 cycles of 630 and 180 seconds with high temperatures, reaching up to 70 °C for washing and 90 °C for rinsing

EAC label upon request

Water supply 55 °C (not on HR version)

Model	DBE	BT	WRAS	DVGW	CONN.	PAP	ID	DF	FLOAT	CONTROL
	Electric Rinse-Aid Disp.	Break Tank	Wras	DVGW	Connectivity (HACCP)	Booster Pump	Double Skin	Surface Filters Kit	Probes lack det and rinse aid	Substitute remote control panel
HT 12 ELECTRON	€	€	€	€	€	€	●	●	€	----
HT 12 ELECTRON DA	€	----	€	€	€	€	●	●	€	----
HT 12 ELECTRON H+	€	€	€	€	€	€	●	●	€	----
HT 12 ELECTRON DA H+	€	----	€	€	€	€	●	●	€	----
HT 12 ELECTRON LIFT	€	€	€	€	€	----	●	●	€	----
HT 12 ELECTRON LIFT DA	€	----	€	€	€	----	●	●	€	----
HT 12 ELECTRON LIFT H+	€	€	€	€	€	----	●	●	€	----
HT 12 ELECTRON LIFT DA H+	€	----	€	€	€	----	●	●	€	----
HT 12 ELECTRON PLUS H+	●	●	€	€	€	●	●	●	€	€
HT 12 ELECTRON PLUS DA H+	●	----	----	----	€	●	●	●	€	€
HT 12 ELECTRON PLUS HR H+	●	●	----	----	€	●	●	●	€	€
HT 12 ELECTRON PLUS HR DA H+	●	----	----	----	€	●	●	●	€	€
HT 12 ELECTRON PLUS LIFT H+	●	●	€	€	€	●	●	●	€	€
HT 12 ELECTRON PLUS LIFT DA H+	●	----	----	----	€	●	●	●	€	€
HT 12 ELECTRON PLUS HR LIFT H+	●	●	----	----	€	●	●	●	€	€
HT 12 ELECTRON PLUS HR LIFT DA H+	●	----	----	----	€	●	●	●	€	€

PS Not available with 380-415 V 3 50 Hz and 440 V 3 60 Hz (PLUS models)







XP In case of cold water supply for rinse (8-55 °C) and without any heat recovery, the extra power option is mandatory. +3000 W with standard voltage only, for other voltages please contact us. In case of cold water supply for rinse (8-15 °C), We recommend the heat recovery option, if available on the selected Model

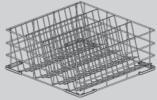
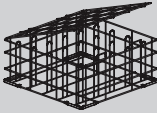

BT-WRAS-DVGW Booster pump included

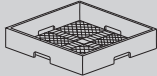
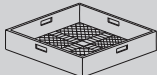
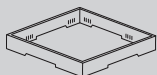
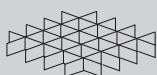
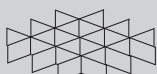
DVGW Components prescribed by DVGW on request (check option compatibility with the manufacturer)

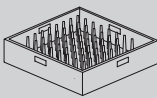
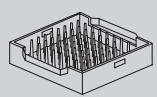
CONNECTIVITY Includes HACCP option. 10-year plan

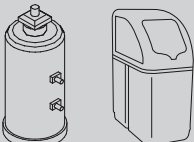
Option compatibility to be confirmed by the manufacturer after verification

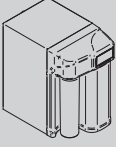
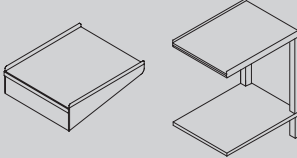
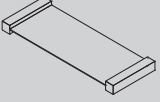
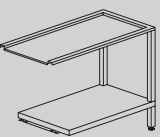
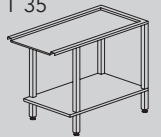
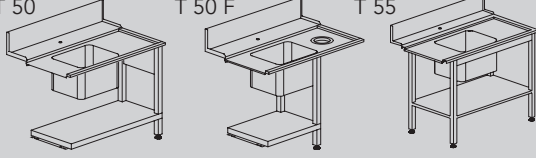
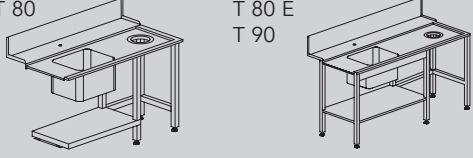
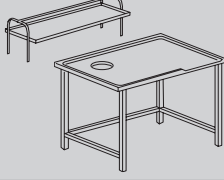
	Description	Capacity	Dimensions	Code	
	SLOPED GLASS BASKET	Ø 100 max	500x500x200 H	C 26	
	REUSABLE CUP BASKET	5x5 glasses 30 mm < Ø < 90 mm H max 185 mm	500x500x235 H	C 135 	
	NARROW MESH CUTLERY BASKET		500x500x106 H	C 41	
	LARGE MESH BASKET	For glasses	500x500x105 H	C 44	
	HOLDER FOR GLASS SUPPORT	For glass support (C112-C113-C114)	500x500x50 H	C111	
	GLASS SUPPORT	5x5 Glass Ø 87 mm (C 111)	500x500x50 H	C 112	
	GLASS SUPPORT	4x4 Glass Ø 110 mm (C 111)	500x500x50 H	C 113	
	GLASS SUPPORT	6x6 Glass Ø 72 mm (C 111)	500x500x50 H	C 114	
	PLATE BASKET	18 Plates	500x500x105 H	C 40	
	GASTRONORM TRAYS BASKET	6 pcs max depth 25mm	500x500x105 H	C 43/B	
	CUTLERY BASKET	Standard (2 pcs)	Ø 120x120 H	15060	
	WATER SOFTENER	12 l	Ø 200x500 H	D 1	
	AUTOMATIC WATER SOFTENER	12 l (max 800 l)	315x510x685 H	D 2	

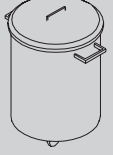
	Description	Capacity	Dimensions	Code
	REVERSE OSMOSIS PLUS MODELS	230 V 50 Hz - 250 W 5° C - 30° C Flow rate 240 l/h Not suitable for machine with integrated water softener Special basket dotation	270x411x451 H 18 Kg	OS 240
	SHELF TABLE	Only for exit	600x510 650x510x860 H	T 10 T 28
	HOOD CONNECTION SHELF			KIT DUO
T 34 A T 34 B 	T 35 	Table	700x590x860 H 1200x590x860 H 1200x590x860 H	T 34 A T 34 B T 35
T 50 T 50 F T 55 	Sink 500x400x270 H		1200x730x860 H 1200x730x860 H 1200x730x860 H	T 50 T 50 F T 55
T 80 T 80 E T 90 	Sink 500x400x270 H		1500x730x860 H 1500x730x860 H 1800x730x860 H	T 80 T 80 E T 90
	SHELF GRADING TABLE WITH RUBBER RING	Waste hole and special dimensions upon request	1515x620x660 H 2315x620x660 H 1600x1000x850 H 2400x1000x850 H	M 16* M 24* TC 16* TC 24*
	FLEXIBLE SHOWER complete with mixing group and lever tap, to be fixed to the wall FLEXIBLE SHOWER complete with mixing group and lever tap, to be fixed to the wall and intermediate tap		1000 H 1000 H	D 01 D 02
	STAINLESS STEEL WASTE BIN	Basic model With wheels With wheels and pedal board	Ø 400x570 H Ø 400x570 H Ø 400x570 H	P 01 P 02 P 03

* Wooden cage +2% minimum + €

Special dimensions for tables upon request

Tables shown in right-to-left version

HT 14 OPTIMA

CONNECTED HOOD-TYPE DISHWASHERS
WITH CLEAN WATER TECHNOLOGY



We simply combined the highest specs and ultimate new technology to the time-tested name and features. HT 14 OPTIMA is our answer to the new high standards of hygiene and cleanliness of the worldwide market, keeping our renowned low operating costs thanks to the OPTIMAL RINSE system. Our HYGIENE+ cycles ($A_0=60$) will guarantee to work safely by keeping top sanitation levels.

The settable additional cycle and the available self-monitoring technology and CONNECTIVITY makes the HT 14 OPTIMA the range you have been expecting. An intuitive and interactive electronic panel will lead you through the new functions of your dishwasher. Its self-diagnosis system notifies any anomaly and clearly shows the different steps of the cycle and status of your dishwasher. 6 wash cycles (8 for the HYGIENE+ version) and the easy change of voltage make these machines incredibly versatile and easy to install.

$A_0=60$
HYGIENE+



HYGIENE+ SYSTEM

Our HYGIENE + models, with high temperatures and long cycles, ensure compliance with high levels of hygiene, nowadays more essential than ever for our personal health. We designed this range according to strict standards and parameters of thermal disinfection. All our HYGIENE + models obtain the A_0 60 level, reducing pathogenic microorganisms and bacterial load according to the norm EN ISO 15883-1. Two cycles with high temperatures (180 and 630 seconds), reaching up to 75°C for washing and 90°C for rinsing, guarantee a full compliance with the disinfection principles.

FEATURES

- **NEW:** automatic two-step hood LIFT
- Partial anticipated drain of waste water thanks to the standard drain-pump, waste wash water is partially drained before rinsing. At each cycle, wash water is cleaner, already warm and added with detergent and rinse-aid
- The innovative deep-formed tank with reduced volume allows significant savings on water, energy and chemicals also avoiding water stagnation
- Standard version: six wash cycles with partial drain of the wash water before rinsing
- HYGIENE+ version: eight wash cycles, six with partial drain of the wash water before rinsing and two HYGIENE+ programs
- Detergent and rinse-aid dosage setting, directly from the control panel
- Self-cleaning vertical pump
- Built-in peristaltic detergent and rinse-aid dispensers
- Double skin insulated hood
- Plus system to grant a constant rinse temperature and pressure
- Water consumption and working time control system
- Break Tank system to prevent backflow contaminations in the piping network
- User-friendly multichrome START key
- Electronic control panel with TFT screen
- Language selection and menu personalization
- Self-diagnostic system, for users and service staff
- Self-cleaning cycle
- Soft Start wash pump
- Automatic built-in water softener version available on demand
- Option available remote control panel
- **CONNECTIVITY** remote control compliant with the HACCP norms (on request)



CONNECTIVITY 4.0 & APP

WHEREVER YOU ARE...
YOUR DISHWASHER, JUST A CLICK AWAY

You will be constantly connected to the machine to monitor the work phases, review any eventual alarm and configure remotely the operating parameters according to your needs. Compliant with HACCP norms. Thanks to our brand new App, you will have access to connected machines and all commercial and technical documentation.

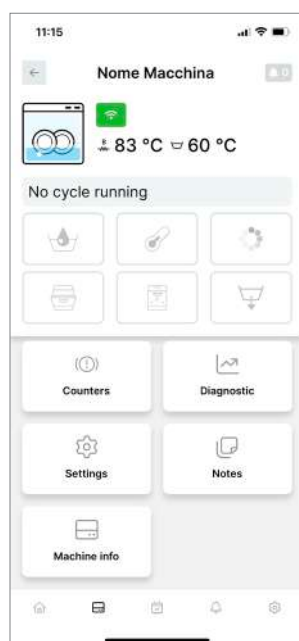

View all the working parameters and event records, working hours and any problem at any time.



In case of problem, the machine promptly alerts you. The technician can intervene remotely to solve the problem or anticipate the needed parts for an on-site intervention.



A daily activity report is available with all the events related to the dishwasher in a detailed spreadsheet with HACCP data.



Our Connectivity system is a revolutionary device limiting and facilitating the eventual intervention of a technician who can anticipate the necessary parts to be replaced, saving time and money.

NEW HIGH-TECH BACKLIT DISPLAY

This new intuitive technology with colored icons, combined with a handy multi-color START, make the machine simple and efficient to use. In addition, the introduction of the new 'customizable cycles' function allows the installer to easily change all parameters related to the wash phase, pause and rinse length and temperatures according to the user's needs. The TFT display provides information on the current status of the machine and on ongoing events such as errors, anomalies, temperatures, cycle selection, cycle progression, lack of salt if water softener included and many other indicators depending on the options selected during the configuration phase.



IMPROVED LIFT SYSTEM:

AUTOMATIC TWO-STEP HOOD LIFT AT THE END OF THE CYCLE

The hydraulic system has been replaced by an electric motor. Its simplicity limits maintenance and the formation of limescale. The latter, freeing up space, allows to add more options to the LIFT models such as the integrated automatic softener.

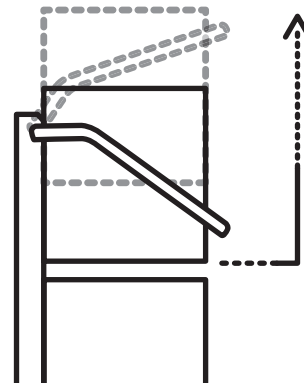





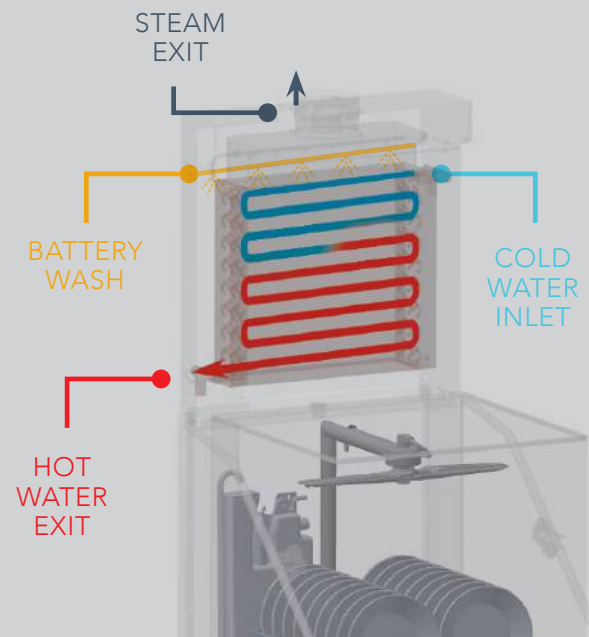





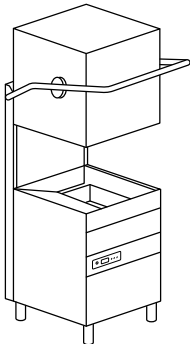



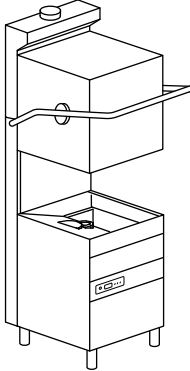

HR - ENERGY RECOVERY

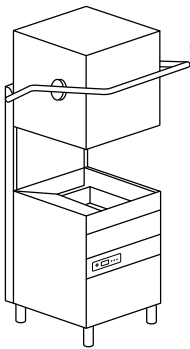
The ENERGY RECOVERY system uses the heat produced by the machine to preheat the inlet cold water (8-15 °C). This is an immediate saving on energy costs. Additionally, an optimal temperature in the dishwashing area is achieved as the air is no more affected by steam and humidity.



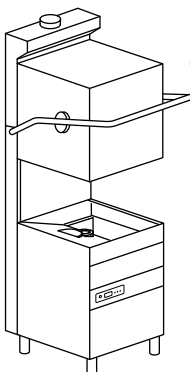







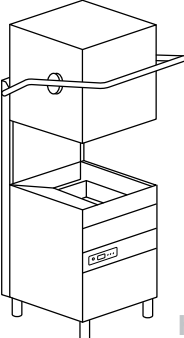



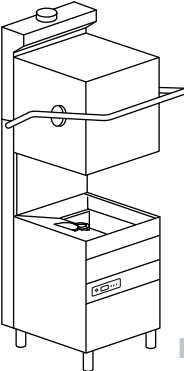

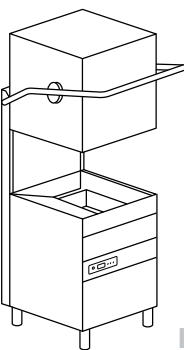

HT 14 OPTIMA

CONNECTED HOOD-TYPE DISHWASHERS
WITH CLEAN WATER TECHNOLOGY

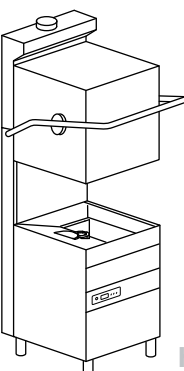
Model	Voltage	Capacity	Dimensions	Code
HT 14 OPTIMA ELECTRONIC 6 PROGRAMS				
 <p>RACK EQUIPMENT 2 X C40 1 X C44 2 X 15060</p>	Multivoltage:			
	standard 400 V 3N 50 Hz (9,9 kW)	 Ø 410	720x735x 1445/1880 H 125 kg	HT 14 OPTIMA
	230 V 3 50 Hz (9,9 kW)	 500x500	 530x325x25 H	HT 14 OPTIMA DA
	--			
	230 V 50 Hz (9,9 kW)			
HT 14 OPTIMA HR ELECTRONIC 6 PROGRAMS - HR: HEAT RECOVERY				
 <p>RACK EQUIPMENT 2 X C40 1 X C44 2 X 15060</p>	Multivoltage:			
	standard 400 V 3N 50 Hz (9,9 kW)	 Ø 410	720x735x 2095 H 145 kg	HT 14 OPTIMA HR
	230 V 3 50 Hz (9,9 kW)	 500x500	 530x325x25 H	HT 14 OPTIMA HR DA
	--			
	230 V 50 Hz (9,9 kW)			
	Cold water supply			
HT 14 OPTIMA LIFT ELECTRONIC 6 PROGRAMS				
 <p>RACK EQUIPMENT 2 X C40 1 X C44 2 X 15060</p>	Multivoltage:			
	standard 400 V 3N 50 Hz (9,9 kW)	 Ø 410	720x735x 1445/1880 H 125 kg	HT 14 OPTIMA LIFT
	230 V 3 50 Hz (9,9 kW)	 500x500	 530x325x25 H	HT 14 OPTIMA LIFT DA
	--			
	230 V 50 Hz (9,9 kW)			
HT 14 OPTIMA HR LIFT ELECTRONIC 6 PROGRAMS - HR: HEAT RECOVERY				
 <p>RACK EQUIPMENT 2 X C40 1 X C44 2 X 15060</p>	Multivoltage:			
	standard 400 V 3N 50 Hz (9,9 kW)	 Ø 410	720x735x 2095 H 145 kg	HT 14 OPTIMA HR LIFT
	230 V 3 50 Hz (9,9 kW)	 500x500	 530x325x25 H	HT 14 OPTIMA HR LIFT DA
	--			
	230 V 50 Hz (9,9 kW)			
	Cold water supply			

X With special basket to be ordered

Model	Voltage	Capacity	Dimensions	Code
HT 14 OPTIMA H+ ELECTRONIC 8 PROGRAMS				
 <p>RACK EQUIPMENT 2 X C40 1 X C44 2 X 15060</p> <p>A₀=60 HYGIENE +</p>	Multivoltage:			
	standard 400 V 3N 50 Hz (9,9 kW)	 ø 410	720x735x 1445/1880 H 125 kg	HT 14 OPTIMA H+
	230 V 3 50 Hz (9,9 kW)	 500x500	 530x325x25 H	HT 14 OPTIMA DA H+
	--			
	230 V 50 Hz (9,9 kW)			
HT 14 OPTIMA HR H+ ELECTRONIC 8 PROGRAMS - HR: HEAT RECOVERY				
 <p>RACK EQUIPMENT 2 X C40 1 X C44 2 X 15060</p> <p>A₀=60 HYGIENE +</p>	Multivoltage:			
	standard 400 V 3N 50 Hz (9,9 kW)	 ø 410	720x735x 2095 H 145 kg	HT 14 OPTIMA HR H+
	230 V 3 50 Hz (9,9 kW)	 500x500	 530x325x25 H	HT 14 OPTIMA HR DA H+
	--			
	230 V 50 Hz (9,9 kW)			
	Cold water supply			
HT 14 OPTIMA LIFT H+ ELECTRONIC 8 PROGRAMS				
 <p>NEW</p> <p>RACK EQUIPMENT 2 X C40 1 X C44 2 X 15060</p> <p>A₀=60 HYGIENE +</p>	Multivoltage:			
	standard 400 V 3N 50 Hz (9,9 kW)	 ø 410	720x735x 1445/1880 H 125 kg	HT 14 OPTIMA LIFT H+
	230 V 3 50 Hz (9,9 kW)	 500x500	 530x325x25 H	HT 14 OPTIMA LIFT DA H+
	--			
	230 V 50 Hz (9,9 kW)			
HT 14 OPTIMA HR LIFT H+ ELECTRONIC 8 PROGRAMS - HR: HEAT RECOVERY				
 <p>NEW</p> <p>RACK EQUIPMENT 2 X C40 1 X C44 2 X 15060</p> <p>A₀=60 HYGIENE +</p>	Multivoltage:			
	standard 400 V 3N 50 Hz (9,9 kW)	 ø 410	720x735x 2095 H 145 kg	HT 14 OPTIMA HR LIFT H+
	230 V 3 50 Hz (9,9 kW)	 500x500	 530x325x25 H	HT 14 OPTIMA HR LIFT DA H+
	--			
	230 V 50 Hz (9,9 kW)			
	Cold water supply			

A₀=60 Special programs complying with A₀ = 60 on the scale of thermo-disinfection according to the norm EN ISO 15883-1. All our Hygiene+ models reach the A₀ 60 level defining the minimum reduction level of pathogenic microorganisms and bacterial load. In addition, our Plus Rinsing System guarantees a perfect rinse with steady temperature and water pressure for optimum hygienic results

HT 14 OPTIMA

CONNECTED HOOD-TYPE DISHWASHERS
WITH CLEAN WATER TECHNOLOGY

OPTIONS

Model					CONTROL	RO	XP	PS	DDE	DBE
	220-240 V 50 Hz	380-415 V 3N 50 Hz	220-240 V 3 50 Hz	60 Hz	Additional remote con- trol panel	Osmosis Connection	Extra Power	Drain Pump	Detergent Dispenser	Peristaltic Rinse-Aid Disp.
HT 14 OPTIMA	M	●	M	€	€	□	€	●	●	●
HT 14 OPTIMA DA	M	●	M	€	€	----	€	●	●	●
HT 14 OPTIMA HR	M	●	M	€	€	□	----	●	●	●
HT 14 OPTIMA HR DA	M	●	M	€	€	----	----	●	●	●
HT 14 OPTIMA H+	M	●	M	€	€	□	€	●	●	●
HT 14 OPTIMA DA H+	M	●	M	€	€	----	€	●	●	●
HT 14 OPTIMA HR H+	M	●	M	€	€	□	----	●	●	●
HT 14 OPTIMA HR DA H+	M	●	M	€	€	----	----	●	●	●
HT 14 OPTIMA LIFT	M	●	M	€	€	□	€	●	●	●
HT 14 OPTIMA LIFT DA	M	●	M	€	€	----	€	●	●	●
HT 14 OPTIMA HR LIFT	M	●	M	€	€	□	----	●	●	●
HT 14 OPTIMA HR LIFT DA	M	●	M	€	€	----	----	●	●	●
HT 14 OPTIMA LIFT H+	M	●	M	€	€	□	€	●	●	●
HT 14 OPTIMA LIFT DA H+	M	●	M	€	€	----	€	●	●	●
HT 14 OPTIMA HR LIFT H+	M	●	M	€	€	□	----	●	●	●
HT 14 OPTIMA HR LIFT DA H+	M	●	M	€	€	----	----	●	●	●

● Standard

□ Upon request

---- Not available

M Multivoltage

DA Built-in automatic water softener

HR Available in case of osmotic water supply, if the electrical conductivity is higher than 200 microsiemens

H+ (HYGIENE+) 2 cycles of 630 and 180 seconds with high temperatures, reaching up to 75 °C for washing and 90 °C for rinsing
Water supply 55 °C (not on HR version)

EAC label upon request

Water supply 55 °C (not on HR version)

Model	TS Electr. Timer + Thermostop	ST Soft Start	BT Break Tank	WRAS Wras	DVGW DVGW	CONNECTIVITY Connectivity (HACCP)	PR Rinse Pump	ID Double Skin	DF Surface Filters Kit	FLOAT Probes lack det and rinse aid
HT 14 OPTIMA	●	●	●	€	€	€	●	●	●	€
HT 14 OPTIMA DA	●	●	----	----	----	€	●	●	●	€
HT 14 OPTIMA HR	●	●	●	----	----	€	●	●	●	€
HT 14 OPTIMA HR DA	●	●	----	----	----	€	●	●	●	€
HT 14 OPTIMA H+	●	●	●	€	€	€	●	●	●	€
HT 14 OPTIMA DA H+	●	●	----	----	----	€	●	●	●	€
HT 14 OPTIMA HR H+	●	●	●	----	----	€	●	●	●	€
HT 14 OPTIMA HR DA H+	●	●	----	----	----	€	●	●	●	€
HT 14 OPTIMA LIFT	●	●	●	€	€	€	●	●	●	€
HT 14 OPTIMA LIFT DA	●	●	----	----	----	€	●	●	●	€
HT 14 OPTIMA HR LIFT	●	●	●	----	----	€	●	●	●	€
HT 14 OPTIMA HR LIFT DA	●	●	----	----	----	€	●	●	●	€
HT 14 OPTIMA LIFT H+	●	●	●	€	€	€	●	●	●	€
HT 14 OPTIMA LIFT DA H+	●	●	----	----	----	€	●	●	●	€
HT 14 OPTIMA HR LIFT H+	●	●	●	----	----	€	●	●	●	€
HT 14 OPTIMA HR LIFT DA H+	●	●	----	----	----	€	●	●	●	€

SOFT START Progressive start of the wash pump

XP In case of cold water supply for rinse (8-55 °C) and without any heat recovery, the extra power option is mandatory. +3000 W with standard voltage only, for other voltages please contact us. In case of cold water supply for rinse (8-15 °C). We recommend the heat recovery option, if available on the selected model.

BT - WRAS - DVGW Booster pump included.

DVGW Components prescribed by DVGW on request (check option compatibility with the manufacturer)





CONNECTIVITY Includes HACCP option. 10-year plan

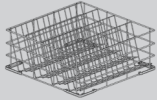
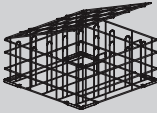

Option compatibility to be confirmed by the manufacturer after verification.

LIFT Automatic two-step hood lift at the end of the cycle

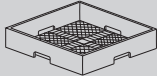
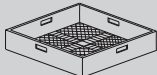
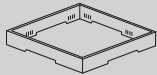
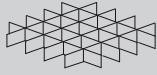
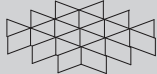
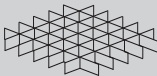
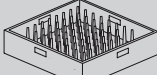
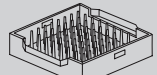
HT 14 OPTIMA

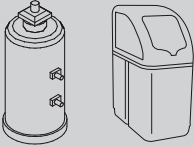
ACCESSORIES

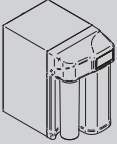
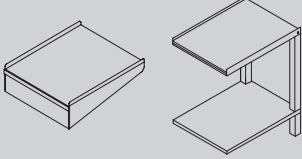
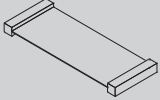
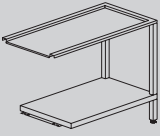
	Description	Capacity	Dimensions	Code	
	SLOPED GLASS BASKET	Ø 100 max	500x500x200 H	C 26	
	REUSABLE CUP BASKET	5x5 glasses 30 mm < Ø < 90 mm H max 185 mm	500x500x235 H	C 135 	
	NARROW MESH CUTLERY BASKET		500x500x106 H	C 41	
	LARGE MESH BASKET	For glasses	500x500x105 H	C 44	
	HOLDER FOR GLASS SUPPORT	For glass support (C112-C113-C114)	500x500x50 H	C111	
	GLASS SUPPORT	5x5 Glass Ø 87 mm (C 111)	500x500x50 H	C 112	
	GLASS SUPPORT	4x4 Glass Ø 110 mm (C 111)	500x500x50 H	C 113	
	GLASS SUPPORT	6x6 Glass Ø 72 mm (C 111)	500x500x50 H	C 114	
	PLATE BASKET	18 Plates	500x500x105 H	C 40	
	GASTRONORM TRAYS BASKET	6 pcs max depth 25mm	500x500x105 H	C 43/B	
	CUTLERY BASKET	Standard (2 pcs)	Ø 120x120 H	15060	
	WATER SOFTENER	12 l	Ø 200x500 H	D 1	
	AUTOMATIC WATER SOFTENER	12 l (max 800 l)	315x510x685 H	D 2	

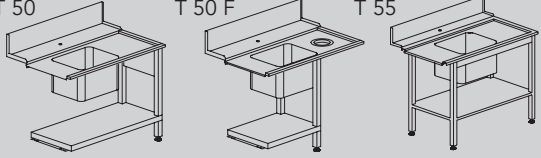
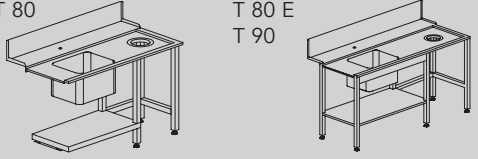
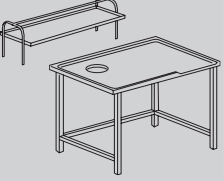
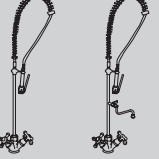
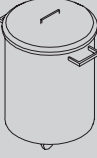
	Description	Capacity	Dimensions	Code
	REVERSE OSMOSIS	230 V 50 Hz - 250 W 5° C - 30° C Flow rate 240 l/h Not suitable for machine with integrated water softener Special basket dotation	270x411x451 H 18 Kg	OS 240
	SHELF TABLE	Only for exit	600x510 650x510x860 H	T 10 T 28
	HOOD CONNECTION SHELF			KIT DUO
T 34 A T 34 B 	T 35 	Table	700x590x860 H 1200x590x860 H 1200x590x860 H	T 34 A T 34 B T 35
T 50 T 50 F T 55 	Sink 500x400x270 H		1200x730x860 H 1200x730x860 H 1200x730x860 H	T 50 T 50 F T 55
T 80 T 80 E T 90 	Sink 500x400x270 H		1500x730x860 H 1500x730x860 H 1800x730x860 H	T 80 T 80 E T 90
	SHELF GRADING TABLE WITH RUBBER RING	Waste hole and special dimensions upon request	1515x620x660 H 2315x620x660 H 1600x1000x850 H 2400x1000x850 H	M 16* M 24* TC 16* TC 24*
	FLEXIBLE SHOWER complete with mixing group and lever tap, to be fixed to the wall FLEXIBLE SHOWER complete with mixing group and lever tap, to be fixed to the wall and intermediate tap		1000 H 1000 H	D 01 D 02
	STAINLESS STEEL WASTE BIN	Basic model With wheels With wheels and pedal board	Ø 400x570 H Ø 400x570 H Ø 400x570 H	P 01 P 02 P 03

* Wooden cage +2% minimum + €

Special dimensions for tables upon request

Tables shown in right-to-left version

TWIN STAR

STOCK & WASH
DISHWASHERS



TWIN STAR does the job for you in full comfort, thanks to its ultra-low-sound level and minimal heat loss in the room. Less handling, less breakages, less repeated job, easy load/unload in full ergonomics. TWIN STAR takes care of it all. Dishes can be used immediately, after the cycles end, or can be left stocked in the machine, as in a shelf. TWIN STAR can be installed in whatever room, as

needing one third of space only, when compared to a traditional dishwashing system. TWIN STAR consumes much less water i.e. much less chemicals. The electrical consumption is minimal and, thanks to the delayed Start, you can run it far from electrical peak times. This allows the reduction of power supply and, mainly, reduces the electricity bill.



DOUBLE FACE VERSION

SAVES 65% ON OVERALL SPACE

TWIN STAR is available in two versions: a front-load one and a pass-through one -embedded in a wall- the second allowing a connection between two rooms, providing a net separation between loading area and clean area (kitchen) reducing even more the needed space.



FEATURES

- Thermo-resistant independent glass doors
- Double-wall construction with thermo-acoustic insulation
- Chemicals dosing and monitoring station
- Cold-fog drying system
- Standard steam condenser
- Automatic, built-in water softener (not for HI TEMP version)
- AISI 316 wash-tank, insulated, with four independent self-cleaning pumps
- Low-sound level
- Can be installed in whatever room
- Consumes remarkably much less water i.e. much less chemicals
- Minimal electrical consumption and possibility to run the machine far from electrical peak times with the delayed Start, reducing the electricity bill
- Installing is easy and fast
- Due to the innovative drying concept, you can immediately pick and use the dishes after the cycle ends
- With the average costs level in Europe, the investment depreciation time ranges between 9 and 12 months depending on the machine's use
- According to our laboratory tests, we deem a life span between 12 to 15 years if the machine is used properly



1. Doors opening not interfering with equipment aside the machine
2. Thermo-resistant independant glass doors
3. Double-wall construction with thermo-acoustic insulation
4. Chemicals dosing and monitoring station, in a front load drawer
5. Cold-fog drying system
6. Standard steam condenser
7. Automatic, built-in water softener (no in HI TEMP version)
8. AISI 316 wash-tank, insulated, with 4 independent self-cleaning pumps
9. New system of wash and rinse arms, ensuring improved wash results



FEATURES

TWIN STAR changes color at each cycle phase, displaying the actual working temperature. A water change at each cycle-stage, grants top hygiene levels. Thanks to the 9 wash-cycles available, just any washing needs are matched: from fragile crystal glasses, to heavily soiled pots.

INNOVATIVE WASH ARMS

The TWIN STAR wash arms keep moving on behalf of your own arms, combining the advantages of the tunnel machines and those of the cycle-machines. With TWIN STAR you can divide the wash areas, according to your needs. Due to the innovative drying concept, you can immediately pick and use the dishes after the cycle ends if needed.

INSTALLATION

Installing a TWIN STAR is easy and fast. Just connect the water circuit drainage and the supply cable and the machine is ready on duty. No steam hoods or vent needed, no floor grids, no water treatment necessary: TWIN STAR is full optional.

Standard applications for the TWIN STAR are: wine-cellars, business restaurants up to 50 covers, family restaurants up to 75 covers, schools, pizzerias, hospital departments, retirement homes, clinics, Police stations and equivalent.



-46%

WATER
CONSUMPTION



-38%

INSTALLED
POWER



-82%

CHEMICAL
CONSUMPTION







-90%

LABOUR

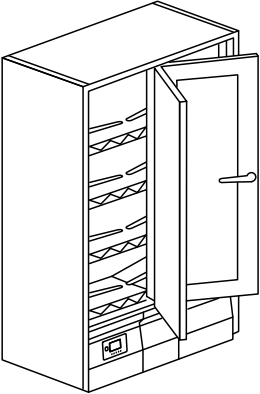
TWIN STAR

STOCK & WASH
DISHWASHERS

Model	Voltage	Capacity	Dimensions	Code
TWIN STAR ELECTRONIC 9 PROGRAMS				
PATENTED				
	400 V 3N ~ 50 Hz 6,5 kW	 220 H - 320 H*  Ø 240 - Ø 330*  530x325x25 H*	1315x747x2043 H 390 kg or 1315x747x1988 H 390 kg (with wheels)	TWIN STAR TWIN STAR HI TEMP

* Upper level only

OPTIONS

	DA	SC	PS
Model	380-415 V 3N 50H	220-240 V 3 50 Hz	220-240 V 50 Hz
	Water Softener	Steam Condenser	Drain Pump
TWIN STAR	●	□	□
TWIN STAR HI TEMP	●	□	□
TWIN STAR DOUBLE FACE	●	□	□
TWIN STAR DOUBLE FACE HI TEMP	●	□	□

- Standard
- Upon request
- Not available

EAC label upon request









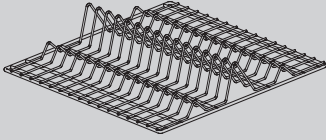

Model	Voltage	Capacity	Dimensions	Code
TWIN STAR DOUBLE FACE	ELECTRONIC 9 PROGRAMS			
PATENTED				
	400 V 3N ~ 50 Hz 6,5 kW	220 H - 320 H*	1315x810x2043 H 400 kg	TWIN STAR DOUBLE FACE
		Ø 240 - Ø 330* 530x325x25 H*	or 1315x810x1988 H 400 kg (with wheels)	TWIN STAR DOUBLE FACE HI TEMP

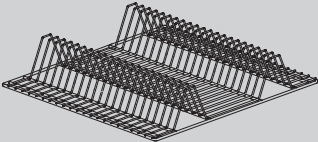
	DDE	DB	D-SAN	FLOAT	ID	DR-F	R
Model	Detergent Dispenser	Rinse aid Dispenser	Sanitizer Dispenser	Probes product shortage	Double skin doors	Cold fog drying system	Wheels
TWIN STAR	●	●	●	●	●	●	€
TWIN STAR HI TEMP	●	●	●	●	●	●	€
TWIN STAR DOUBLE FACE	●	●	●	●	●	●	€
TWIN STAR DOUBLE FACE HI TEMP	●	●	●	●	●	●	€

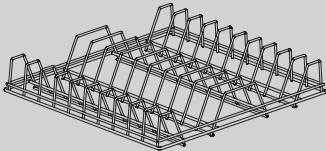

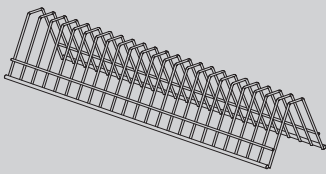

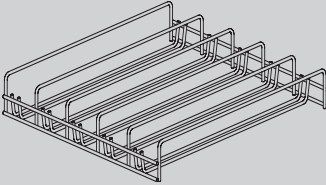



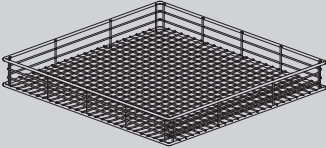

TWIN STAR With water softener, water supply max 45°C - Water hardness < 20 °f

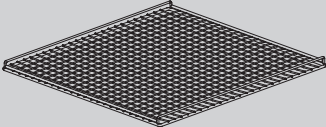
TWIN STAR HI TEMP Without water softener, water supply max 65 °C - Max water hardness 5 °f, if higher an external water softener is required

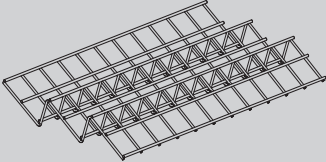
Option compatibility to be confirmed by the manufacturer after verification

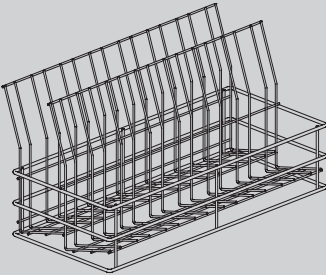
	Description	Capacity	Dimensions	Code
	RACK FOR PLATES AND TRAYS	30 pcs 15 pcs	 210 <math><\text{Ø}>>240</math> 250 <math><\text{Ø}>>330^*</math> max depth 40	590071
		15 pcs	 530x325x25 H*	
	RACK FOR FLAT DISHES	42 pcs	 250x15 max depth 15	590072
	RACK FOR PLATES	20 pcs 10 pcs	 210 <math><\text{Ø}>>240</math> 250 <math><\text{Ø}>>330^*</math> max depth 70	590124
		10 pcs	 530x325x25 H*	
	SAUCER SUPPORT in combination with 590074 or 590075	23 pcs	 $\text{Ø}<240</math> $	590078
	BOWLS SUPPORT in combination with 590074	8 pcs 20 pcs	 $\text{Ø} 235</math> depth 100 \text{Ø} 110</math> depth 50 $	590128

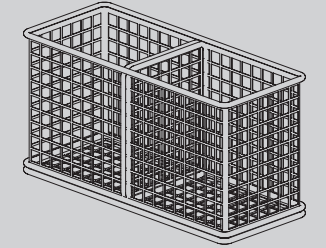
*upper level only

	Description	Capacity	Dimensions	Code	
	RACK FOR MUGS AND LOW GLASSEST	25 pcs	 Ø 100	590074	
	RACK FOR MUGS AND LOW GLASSES	25 pcs	 Ø 100	590075	
	CUPS SUPPORT FOR 590074 / 590075 in combination with 590074	24 pcs	 Ø < 55	590076	
	SUPPORT FOR TALL GLASSES in combination with 590075	8 pcs	 Ø 100	590077	
	CUTLERY SUPPORT in combination with 590074 or 590075	30 pcs		590080	

RX COMPACT

COMPACT RACK-TYPE DISHWASHERS
WITH SIMPLE RINSE



The RX COMPACT dishwashers line has been designed to satisfy the demand of medium and small restaurants. These machines combine com-

pact dimensions with high performances. We now introduce the new line with electromechanical panel to enhance the usability.

CUSTOMIZABLE AND REVERSIBLE

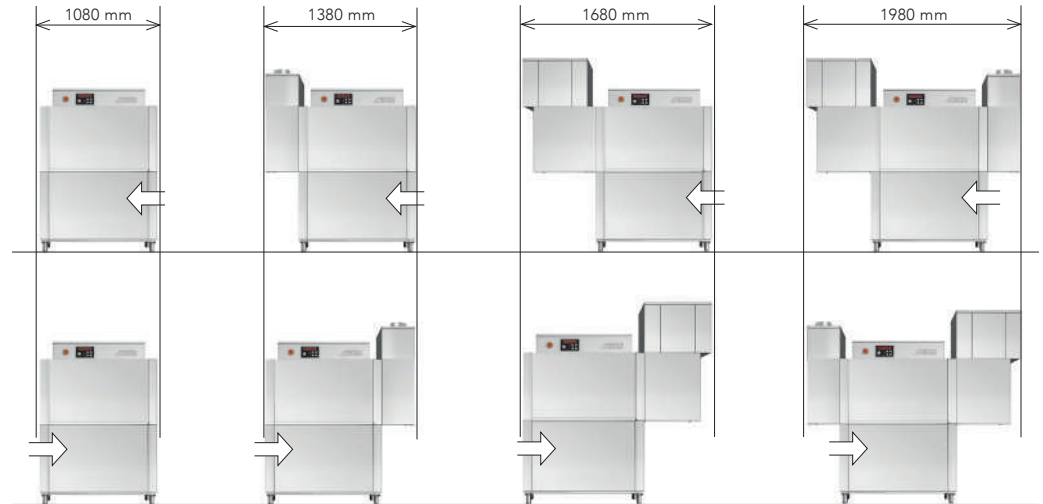







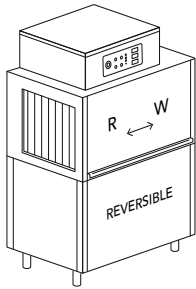

FEATURES



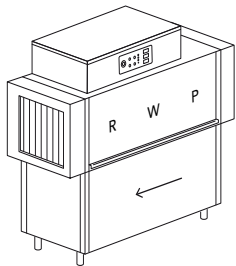

- Sloped radial wash tanks to help emptying the tanks
- Self-cleaning vertical wash pumps, protected from electrical overloads
- Traction system with built-in clutch preventing derailment
- AISI 304 stainless steel boilers, fully insulated to reduce thermal losses
- Simple and intuitive touch control panel or electromechanical panel
- S/S wash and rinse arms. These are removable without using any tool
- S/S surface filters on every tank, easily removable without detaching wash arms
- Insulated double skin door, counterbalanced, equipped with anti-drop safety system
- DRIVE speed variator with 3 speeds on the electromechanical versions and 5 speeds on the electronic versions
- Autotimer in order to switch off the rack-type motor as well as other machine's options (electronic version)
- Economizers to allow operation only when the rack is detected on that specific area
- Pressure reducer, to stabilize the water pressure and grant an optimal final rinse
- Non-return valve to prevent the water backflow
- Linear or 90° arc drying module (option)
- Sanitization system which includes the sanitizing product dispensers (option for electronic version only)
- Heat recovery in case of cold water inlet (8-15 °C) (option)

RX COMPACT

COMPACT RACK-TYPE DISHWASHERS
WITH SIMPLE RINSE

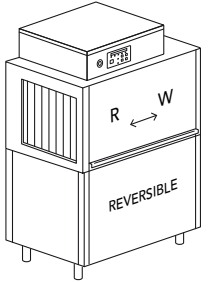
Model		Voltage	Capacity	Dimensions	Code
RX 101	3 SPEEDS				
	<p>RACK EQUIPMENT</p> <ul style="list-style-type: none"> 1 X C40 1 X C43 1 X C44 1 X C47 	400 V 3N ~ 50 Hz 19,1 kW	 Ø 450  500x500 66* - 100 racks/h	1080 x 715 1690/1900 H 210 kg  530x325x25 H	RX 101
RX 164	3 SPEEDS				
	<p>RACK EQUIPMENT</p> <ul style="list-style-type: none"> 1 X C40 1 X C43 1 X C44 1 X C47 	400 V 3N ~ 50 Hz 23,6 kW	 Ø 450  500x500 86* - 150 racks/h	1880 x 715 1690/1900 H 270 kg  530x325x25 H	RX 164

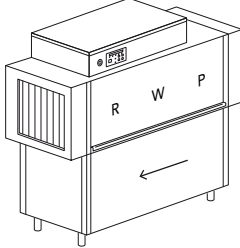
- P** Prewash
- W** Wash
- R** Single rinse
- *** Productivity according to DIN SPEC 10534 (contact time)

Model	Voltage	Capacity	Dimensions	Code
RX 101 E 	ELECTRONIC 5 SPEEDS 400 V 3N ~ 50 Hz 19,1 kW	 500x500 66* - 100 racks/h	1080 x 715 1565/1900 H 210 kg  530x325x25 H	RX 101 E
RX 164 E 	ELECTRONIC 5 SPEEDS 400 V 3N ~ 50 Hz 23,6 kW	 500x500 86* - 150 racks/h	1880 x 715 1565/1900 H 270 kg  530x325x25 H	RX 164 E

OPTIONS

Model	220-240 V 3 50 Hz			380-415 V 3N 50 Hz			60 Hz	XP	PRE DOS	DDE-GROUP	DOS/S	DRIVE		AUTOTIMER		
	€	●	+3%	€	●	+3%	€	●	€	€	●	●	----	●	----	----
RX 101	€	●	+3%	€	●	+3%	€	●	€	€	●	●	----	●	----	----
RX 164	€	●	+3%	€	●	+3%	€	●	€	€	●	●	----	●	----	----
RX 101 E	€	●	+3%	€	●	+3%	€	●	€	€	●	●	€	●	●	●
RX 164 E	€	●	+3%	€	●	+3%	€	●	€	€	●	●	----	●	●	●

● Standard

---- Not available

E Electronic panel

DRA924 Available only without LC77/2 - LC77/3 on entry

LC77/2 - LC77/3 Available on entry or exit connections, one per layout

DDE-GROUP Both detergent (with probe) and rinse-aid dispensers included

DOS/S For detergent dispenser only

HIGH SPEED Extra power included. Hot water inlet 55°C

AUTOTIMER Functioning only when combined with DR24, DRA924, SC5, HR5

Water supply 55 °C - We recommend to install the machine in a well ventilated room, with a properly sized steam exhausting system

Construction according to UL-NSF standards upon request

EAC label upon request

Option compatibility to be confirmed by the manufacturer after verification

AVAILABLE ARCS:



LC97

1300x1300x860 H

90° roller arc with tank

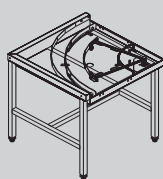

LC77/2

850x850x885 H

90° mechanized arc

(clockwise/counter-clockwise)

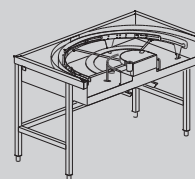

LC77/3

850x1500x885 H

180° mechanized arc

(clockwise/counter-clockwise)

Model	BT	DVGW	DWI/T	DWI	PI	PAP	SAN	PAP-SAN	DIV	SC5	HR5	DR24	DRA924	LC73
	Break Tank	DVGW	Tank insulation	Thermoacoustic insulation	S/S pumps	Booster pump	Sanitization System	Booster Pump Sanitization	Price for division	Steam cond.	Heat recovery	Dryer	Dryer 90° arc	Splash guard
RX 101	----	----	€	€	€	€	----	----	€	€	€	€	€	€
RX 164	----	----	€	€	€	€	----	----	€	€	€	€	€	●
RX 101 E	€	€	€	€	€	€	€	€	€	€	€	€	€	€
RX 164 E	€	€	€	€	€	€	€	€	€	€	€	€	€	●

BT Booster pump included

DVGW Not available with heat recovery and steam condensera
Components prescribed by DVGW on request (check option compatibility with the manufacturer)

DWI - DWI/T Recommended with HR5

PI Available with 50 Hz frequency only

SAN Including dosing system for sanitizing product

HR5 With osmotic water supply and electrical conductivity lower than 200 microsiemens, it is mandatory to install a stainless steel heat exchanger

XP In case of cold water supply for rinse (8-55 °C) and without any heat recovery, the extra power option is mandatory. In case of cold water supply for rinse (8-15 °C), we recommend the heat recovery option

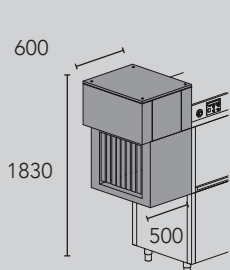

DR24
4,5 kW
Dryer

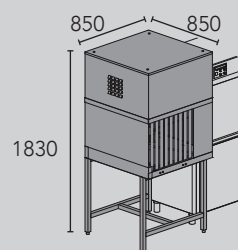



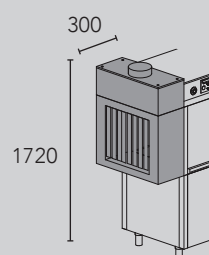

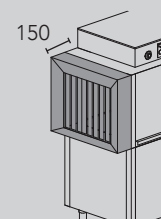

DRA924
4,5 kW
Dryer with mechanized arc 90° to be used with original DIHR racks only

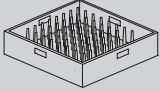
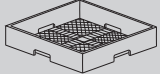
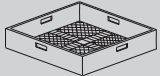
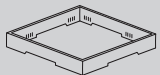

SC5
Steam condenser
HR5
Compact heat recovery only

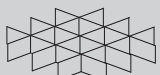

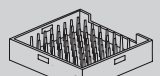
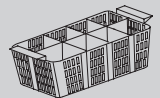
LC73
Splash guard

	Description	Capacity	Dimensions	Code
	PLATE BASKET	18 Plates	500x500x105 H	C 40
	NARROW MESH CUTLERY BASKET		500x500x106 H	C 41
	LARGE MESH BASKET	For glasses	500x500x105 H	C 44
	HOLDER FOR GLASS SUPPORT	For glass support (C112-C113-C114)	500x500x50 H	C111
	GLASS SUPPORT	5x5 Glass Ø 87 mm (C 111)	500x500x50 H	C 112
	GLASS SUPPORT	4x4 Glass Ø 110 mm (C 111)	500x500x50 H	C 113
	GLASS SUPPORT	6x6 Glass Ø 72 mm (C 111)	500x500x50 H	C 114
	TRAYS BASKET	6 pcs max depth 25mm	500x500x105 H	C 43
	CUTLERY BASKET		490x180x140 H	C 47
	FLEXIBLE SHOWER complete with mixing group and lever tap, to be fixed to the wall		1000 H	D 01
	FLEXIBLE SHOWER complete with mixing group and lever tap, to be fixed to the wall and intermediate tap		1000 H	D 02

	Description	Capacity	Dimensions	Code
	SHELF		1515x620x660 H	M 16*
			2315x620x660 H	M 24*
	GRADING TABLE WITH RUBBER RING	Waste hole and special dimensions upon request	1600x1000x850 H	TC 16*
			2400x1000x850 H	TC 24*
	MECHANIZED GRADING TABLE With mechanized basket advancement system	1 waste hole	1800x1240 1525 H	RTC 18*
		2 waste holes	2400x1240 1525 H	RTC 24*
			1200x590x860 H	T 35
			1200x730x860 H	T 55
			1500x730x860 H	T 80
			1800x730x860 H	T 90
		Standard rubber ring		
		Standard rubber ring		
		Sink 500x400x270 H		
		Sink 500x400x270 H		
	ROLLER TABLE + sink, right or left version		1600x730x860 H	T 195
	Sink 500x400x270 H			
	LINEAR ROLLER TABLE WITH TANK		1100x650x860 H	LC 96/A*
			1600x650x860 H	LC 96/B*
			2100x650x860 H	LC 96/C*
		Option end microswitch		LC 95
	LINEAR ROLLER TABLE WITH TANK complete with end microswitch	Not compatible with same references Not on 180° arcs	1100x650x860 H	LC 96/1
			1600x650x860 H	LC 96/1A
		To be connected to LC77/3 only and to dryer on 180°	1150x650x860 H	LC 96/2
			1650x650x860 H	LC 96/2A
	90° roller arc with tank (exit only with roller table)		1300x1300x860 H	LC 97*
	ANGLE LOADING TABLE complete with basket pull-through system	Optional connection to prewash tables	700x610x820 H	LC 98
	90° mechanized arc clockwise/counter-clockwise, not available at the entry + LC version	Available on entry or exit connections, one per layout. To be used with original DIHR racks only	850x850x885 H	LC 77/2*
	180° mechanized arc (clockwise/counter-clockwise)		850x1500x885 H	LC 77/3*

* Wooden cage +2% minimum + € / Special dimensions for tables upon request / Tables shown in right-to-left version
We strongly recommend the presence of a roller table with end microswitch at the exit of our rack-type machines for a correct operation



DIHR introduces RX EVO with single rinse. This new range of rack-type dishwashers, thanks to the new single tank configuration, meets the DIN 10512 norm with a contact of 90 seconds.

Combined with numerous accessories, this new line of RX EVO offers personalized solutions for all demands.



FEATURES

STANDARD

- Double-skin, insulated and counterbalanced doors, equipped with anti-drop safety system
- Ergonomic handles
- Thermo barrier system for comfort in use
- Acid proof AISI 316 stainless steel radial wash tanks
- CLEAN+ filters
- Self-cleaning vertical wash pumps, protected from electrical overloads
- Wash arms ALL-IN-1
- CPF System
- Side traction system with built-in clutch
- Variatore di velocità DRIVE a 5 velocità
- Use economizer
- Acid proof AISI 316 stainless steel boilers, fully insulated to reduce thermal loss
- Autotimer switching off the rack-type motor and all electrical options after a preset lapse of inactivity
- Single rinse R with limited consumptions
- Control panel with IPX5 membrane keyboard

OPTIONS

- Linear and 90°/180° corner drying modules, power 4,5 kW or 9 kW (double skin dryer available for linear models only)
- Steam condenser (SC10)
- Two models of heat recovery to be chosen according to the type of machine (compact or with integrated heat pump)
- Detergent dispenser with probe or dispensers kit
- Booster pump
- Hydraulic security system Break Tank
- Extra power for the boiler
- Thermal and acoustic insulation
- Stainless steel pumps
- Centralized drain 1-DRAIN
- Delivery in 2 or more parts to facilitate handling
- Machine sanitization also with dedicated booster pump
- Variable speed inverter "drive" with 5 speeds

Model	Voltage	Capacity	Dimensions	Code
RX 102 E 5 SPEEDS	400 V 3N ~ 50 Hz 21,9 kW	Ø 450 500x500 80*-112 racks/h	1900x805x 1830/2120 H 300 kg GN 1/1 530x325x25 H	RX 102 E

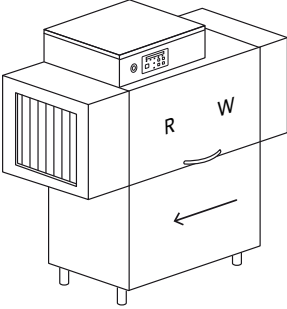

RACK EQUIPMENT



- 1 X C40
- 1 X C43
- 1 X C44
- 1 X C47

- P** Prewash
- W** Wash
- R** Single rinse

OPTIONS

Model	220-240 V 3 50 Hz	380-415 V 3N 50 Hz	60 Hz	PRE DOS DIHR disp. connections	DDE-GROUP Dispensers kit	DOS/S Dispenser with Probe	SAN Saniti- zation	PAP-SAN Booster Pump Sani- tiz.	DWI Thermoacou- stic Insulation	PAP Booster pump
RX 102 E	€	●	+3%	●	€	€	€	€	€	€
RX 142 E	€	●	+3%	●	€	€	€	€	€	€

- Standard
- Not available
- E** Settable electronic panel
- DDE-GROUP** Both detergent with probe and rinse-aid dispensers included
- DOS/S** For detergent dispenser only
- SAN** Including dosing system for sanitizing product
- DWI** Insulation option for the tunnel only, dryer excluded. Shelf dryer can be insulated upon request. Recommended with HR10 – HRP40
- DIV** Only splash guards removable
- XP** In case of cold water supply for rinse (8-55 °C) and without any heat recovery, the extra power option is mandatory

Model	Voltage	Capacity	Dimensions	Code
RX 142 E 5 SPEEDS	400 V 3N ~ 50 Hz 19,7 kW	 Ø 450  500x500 93-144 racks/h 119* racks/h	2100x805x 1830/2120 H 310 kg  530x325x25 H	RX 142 E

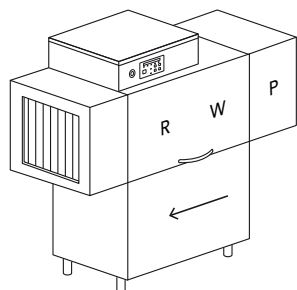

RACK EQUIPMENT
 1 X C40
 1 X C43
 1 X C44
 1 X C47

* Productivity according to DIN SPEC 10534 (contact time)

	DRIVE	AUTOTIMER	BT	DVGW	XP	DIV	PI	1-DRAIN
Model	Smart drive	Autotimer	Break Tank	DVGW	Extra Power	Price for division	S/S Pumps	Centralized Drain
RX 102 E	●	●	€	€	€	€	€	●
RX 142 E	●	●	€	€	€	€	€	●

- PI** Available with 50 Hz frequency only
- DVGW** Not available with heat recovery or steam condenser
- BT** Booster pump included
- DRIVE** Check voltage compatibility

With osmotic water supply and electrical conductivity lower than 200 microsiemens, it is mandatory to install a stainless steel heat exchanger

We recommend to install the machine in a well ventilated room, with a properly sized steam exhausting system

Peak-cut connect upon request

Warm water supply 55 °C

EAC label upon request

Option compatibility to be confirmed by the manufacturer after verification

OPTIONS

	SC10	HR10	HRP40	DR64	DR69	DR94
Model	Steam condenser	Heat recovery	Heat recovery	Dryer + 400 mm 4,5 kW	Dryer + 400 mm / 9 kW	Dryer + 700 mm / 4,5 kW
RX 102 E	€	€	€	€	€	€
RX 142 E	€	€	----	€	€	€

- Standard
- Not available

HRP40 Available with 400 V 3N 50 Hz frequency only

HR10 - HRP40 In case of cold water supply for rinse (8-15 °C), we recommend to install the heat recovery system optional.
Extra power included

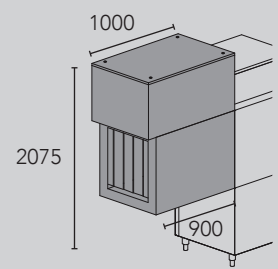
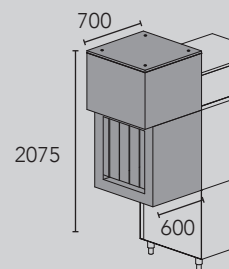
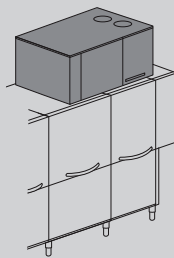
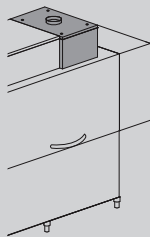
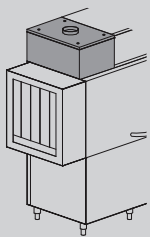

SC10
Steam condenser

HR10
Compact heat recovery

HRP40
Heat recovery with heat pump

DR64 4,5 kW Electric
DR69 9 kW Electric
Dryer

DR94 4,5 kW Electric
DR99 9 kW Electric
Dryer

	DR99	DRA94MC	DRA99MC	DRA184MC	DRA189MC	ID
Model	Dryer + 700 mm / 9 kW	Mechanized dryer 90° arc 4,5 kW	Mechanized dryer 90° arc 9 kW	Mechanized dryer 180° arc 4,5 kW	Mechanized dryer 180° arc 9 kW	Double skin for dryer
RX 102 E	€	€	€	€	€	€
RX 142 E	€	€	€	€	€	€

ID Recommended for DR69 - DR99. Not available for corner dryers

LC77/2 - LC77/3 Available on entry or exit connections, one per layout

DRA184MC - DRA189MC Mandatory division

DR64 - DR94 - DRA94MC - DRA184MC Verify feasibility with manufacturer

DRA94MC - DRA99MC - DRA184MC - DRA189MC Available only without LC77/2 - LC77/3 on entry

Option compatibility to be confirmed by the manufacturer after verification

AVAILABLE ARCS:

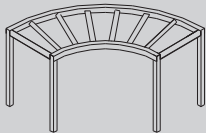

LC97 1300x1300x860 H
90° roller arc with tank

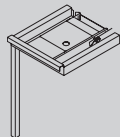

LC98 700x610x820 H
Angle loading table
complete with basket
pull-through system

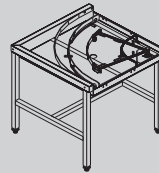

LC77/2 850x850x885 H
90° mechanized arc
(clockwise/counter-clockwise)
to be used with original DIHR
racks only

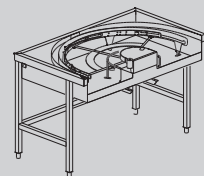

LC77/3 850x1500x885 H
180° mechanized arc
(clockwise/counter-clockwise)
to be used with original DIHR
racks only

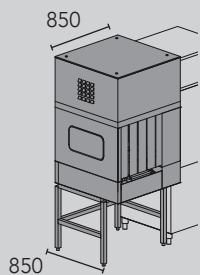

DRA94MC 4,5 kW Electric
DRA99MC 9 kW Electric
Dryer with mechanized arc 90° to
be used with original DIHR racks
only

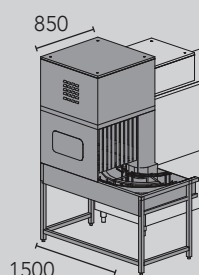

DRA184MC 4,5 kW Electric
DRA189MC 9 kW Electric
Dryer with mechanized arc 180° to
be used with original DIHR racks
only



DIHR presents the RX EVO line of rack-type dishwashers with double rinse: a range of models with multiple accessories to offer tailor-made solutions for any customer needs.

Thanks to the efficient pre-rinse and rinse system, we have achieved a radical reduction in water consumption, up to using approximately one liter of water per basket only.

Pre-rinse saves water, rinse-aid and electricity because the water used for rinsing is collected and sent to the pre-rinse arms.. This result, besides respecting the environment, significantly saves chemicals and reduces the need for energy.



CONTROL PANEL

The RX EVO control panel with IPX5 membrane keyboard, allows both technicians and users to obtain comprehensive and detailed information on the machine operation. Its display with scrolling text provides data about the current status of the machine, such as boiler and tank temperatures, main alert codes and various programmable settings. The user-friendly control board, combined with the clear set of information provided to the user, make of DIHR display a reliable and effective control device for our machine.













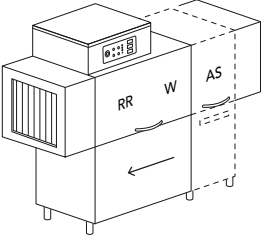



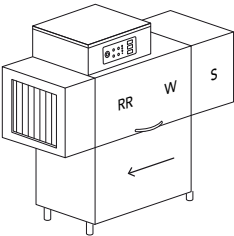



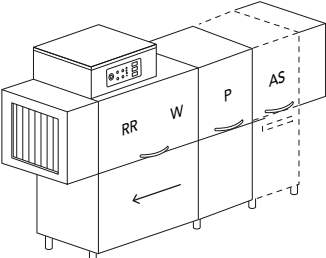

FEATURES

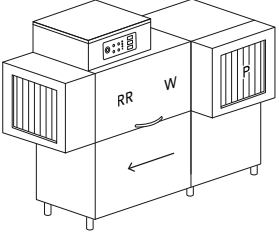
STANDARD

- Electromechanical control panel
- Improved double rinse RR, more effective and with limited consumptions
- Double lateral drive system with incorporated clutch
- DRIVE speed variator with 3 speeds on the electromechanical versions and 5 speeds on the electronic versions
- AISI 316 stainless steel tanks and boilers

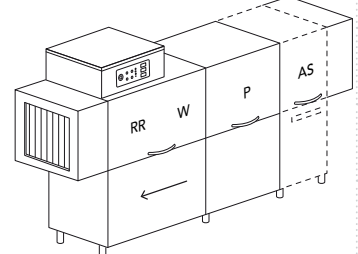









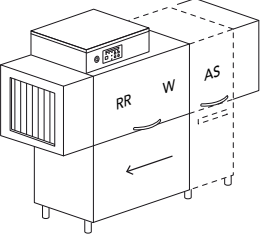



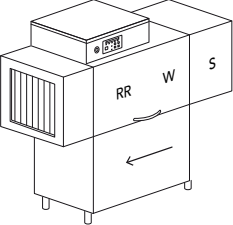



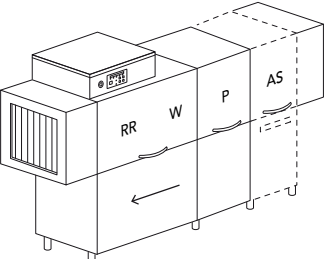

OPTIONS

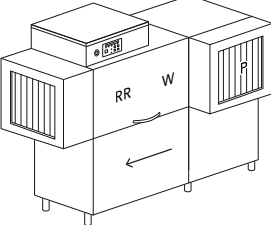
- Control panel with IPX5 membrane keyboard
- Linear and 90°/180° corner drying modules, power 4,5 kW or 9 kW (double skin dryer available for linear models only)
- Steam condenser (SC10)
- Three models of heat recovery to be chosen according to the type of machine (compact, standard, or with built-in heat pump)
- Detergent dispenser with probe or dispensers kit
- Booster pump
- Water pressure security system Break Tank
- Extra power for the boiler
- Thermal and acoustic insulation
- Stainless steel pumps
- Centralized drain 1-DRAIN
- Variable speed inverter "drive" with 5 speeds (electronic version).
- Delivery in 2 or more parts to facilitate handling
- Machine sanitization (for electronic versions only) with dedicated booster pump

Model		Voltage	Capacity	Dimensions	Code
RX 104	3 SPEEDS				
	<p>RACK EQUIPMENT</p> <ul style="list-style-type: none"> 1 X C40 1 X C43 1 X C44 1 X C47 	400 V 3N ~ 50 Hz 19,90 kW	 Ø 450  500x500 80*-112 rack/h	1900x805 1830/2120 H 245 kg AS + 450 mm  530x325x25H	RX 104 RX 104 AS
RX 144	3 SPEEDS				
	<p>RACK EQUIPMENT</p> <ul style="list-style-type: none"> 1 X C40 1 X C43 1 X C44 1 X C47 	400 V 3N ~ 50 Hz 20,60 kW	 Ø 450  500x500 93*-144 rack/h	2100x805 1830/2120 H 270 kg  530x325x25H	RX 144
RX 184	3 SPEEDS				
	<p>RACK EQUIPMENT</p> <ul style="list-style-type: none"> 1 X C40 1 X C43 1 X C44 1 X C47 	400 V 3N ~ 50 Hz 23,82 kW	 Ø 450  500x500 115*-192 rack/h	2500x805 1830/2120 H 355 kg AS + 450 mm  530x325x25H	RX 184 RX 184 AS
RX 184 LC	3 SPEEDS - CORNER PREWASH				
	<p>RACK EQUIPMENT</p> <ul style="list-style-type: none"> 1 X C40 1 X C43/B 1 X C44 1 X C47 	400 V 3N ~ 50 Hz 23,82 kW	 Ø 450  500x500 115-192 rack/h	2225x985 1830/2120 H 355 kg  530x325x25H	RX 184 LC
RX 244	3 SPEEDS				
	<p>RACK EQUIPMENT</p> <ul style="list-style-type: none"> 1 X C40 1 X C43 1 X C44 1 X C47 	400 V 3N ~ 50 Hz 28,10 kW	 Ø 450  500x500 132*-240 rack/h	2800x805 1830/2120 H 395 kg AS + 450 mm  530x325x25H	RX 244 RX 244 AS

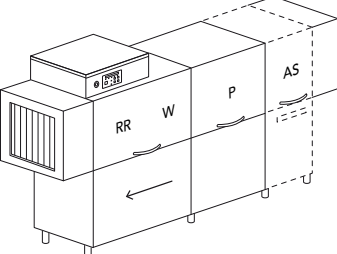
P Prewash
W Wash
RR Pre-rinse + rinse

LC Corner prewash
AS Automatic shower with filter drawer +450 mm
S Soaking

Model		Voltage	Capacity	Dimensions	Code
RX 104 E	5 SPEEDS				
	<p>RACK EQUIPMENT</p> <ul style="list-style-type: none"> 1 X C40 1 X C43 1 X C44 1 X C47 	400 V 3N ~ 50 Hz 19,90 kW	 Ø 450  500x500 80*-112 rack/h	1900x805 1830/2120 H 245 kg AS + 450 mm  530x325x25H	RX 104 E RX 104 E AS
RX 144 E	5 SPEEDS				
	<p>RACK EQUIPMENT</p> <ul style="list-style-type: none"> 1 X C40 1 X C43 1 X C44 1 X C47 	400 V 3N ~ 50 Hz 20,60 kW	 Ø 450  500x500 93*-144 rack/h	2100x805 1830/2120 H 270 kg  530x325x25H	RX 144 E
RX 184 E	5 SPEEDS				
	<p>RACK EQUIPMENT</p> <ul style="list-style-type: none"> 1 X C40 1 X C43 1 X C44 1 X C47 	400 V 3N ~ 50 Hz 23,82 kW	 Ø 450  500x500 115*-192 rack/h	2500x805 1830/2120 H 355 kg AS + 450 mm  530x325x25H	RX 184 E RX 184 E AS
RX 184 E LC	5 SPEEDS - CORNER PREWASH				
	<p>RACK EQUIPMENT</p> <ul style="list-style-type: none"> 1 X C40 1 X C43/B 1 X C44 1 X C47 	400 V 3N ~ 50 Hz 23,82 kW	 Ø 450  500x500 115-192 rack/h	2225x985 1830/2120 H 355 kg  530x325x25H	RX 184 E LC
RX 244 E	5 SPEEDS				
	<p>RACK EQUIPMENT</p> <ul style="list-style-type: none"> 1 X C40 1 X C43 1 X C44 1 X C47 	400 V 3N ~ 50 Hz 28,10 kW	 Ø 450  500x500 132*-240 rack/h	2800x805 1830/2120 H 395 kg AS + 450 mm  530x325x25H	RX 244 E RX 244 E AS

* Productivity according to DIN SPEC 10534 (contact time)

OPTIONS

Model	PRE DOS DDE-GROUP			DOS/S	SAN	PAP-SAN	SC10	HR10	HR20	HRP40		
	220-240 V 3 50 Hz	380-415 V 3N 50 Hz	60 Hz	DIHR disp. connec- tions	Dispensers kit	Dispenser with Probe	Saniti- zation	Booster Pump Sanitiz.	Steam condenser	Heat recovery	Heat recovery	Heat recovery
RX 104	€	●	+3%	●	€	€	----	----	€	€	----	----
RX 104 AS	€	●	+3%	●	€	€	----	----	€	€	----	----
RX 104 E*	€	●	+3%	●	€	€	€	€	€	€	----	€
RX 104 E AS	€	●	+3%	●	€	€	€	€	€	€	----	€
RX 144	€	●	+3%	●	€	€	----	----	€	€	----	----
RX 144 E	€	●	+3%	●	€	€	€	€	€	€	----	€
RX 184	€	●	+3%	●	€	€	----	----	€	€	€	----
RX 184 AS	€	●	+3%	●	€	€	----	----	€	€	€	----
RX 184 E	€	●	+3%	●	€	€	€	€	€	€	€	€
RX 184 E AS	€	●	+3%	●	€	€	€	●	€	€	€	€
RX 184 LC	€	●	+3%	●	€	€	----	----	€	€	----	----
RX 184 E LC	€	●	+3%	●	€	€	€	€	€	€	----	€+
RX 244	€	●	+3%	●	€	€	----	----	€	€	€	----
RX 244 AS	€	●	+3%	●	€	€	----	----	€	€	€	----
RX 244 E*	€	●	+3%	●	€	€	€	€	€	€	€	€
RX 244 E AS	€	●	+3%	●	€	€	€	●	€	€	€	€

● Standard

---- Not available

E Settable electronic panel

HRP40 Available with 400 V 3N 50 Hz frequency only

HR10 - HR20 - HRP40 In case of cold water supply for rinse (8-15 °C), we recommend to install the heat recovery system optional. Extra power included

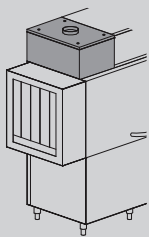

SC10

Steam condenser

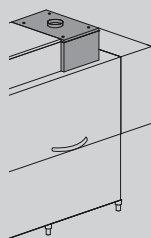

HR10

Compact Heat recovery

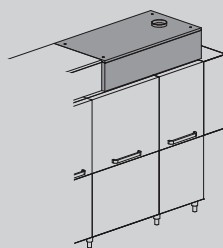

HR20

Heat recovery

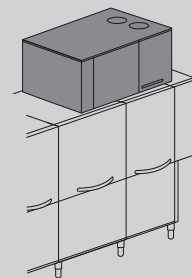

HRP40

Heat recovery
with heat pump

	DWI	PAP	DRIVE	AUTOTIMER	BT	DVGW	XP	DIV	PI	1-DRAIN
Model	Thermo-acoustic Insulation	Booster pump	Smart drive	Autotimer	Break Tank	DVGW	Extra Power	Price for division	S/S Pumps	Centralized Drain
RX 104	€	€	●	----	----	----	€	€	€	€
RX 104 AS	€	€	●	----	----	----	€	€	€	€
RX 104 E*	€	€	●	●	€	€	€	€	€	€
RX 104 E AS	€	€	●	●	€	€	€	€	€	€
RX 144	€	€	●	----	----	----	€	€	€	€
RX 144 E	€	€	●	●	€	€	€	€	€	€
RX 184	€	€	●	----	----	----	€	€	€	€
RX 184 AS	€	€	●	----	----	----	€	€	€	€
RX 184 E	€	€	●	●	€	€	€	€	€	€
RX 184 E AS	€	€	●	●	€	€	€	€	€	€
RX 184 LC	€	€	●	----	----	----	€	€	€	€
RX 184 E LC	€	€	●	●	€	€	€	€	€	€
RX 244	€	€	●	----	----	----	€	€	€	€
RX 244 AS	€	€	●	----	----	----	€	€	€	€
RX 244 E*	€	€	●	●	€	€	€	€	€	€
RX 244 E AS	€	€	●	●	€	€	€	€	€	€

+ Not available for LC version if the machine is next to the wall

***** Construction according to UL-NSF standards upon request

DDE-GROUP Both detergent and rinse-aid dispensers included (with probe)

DOS/S For detergent dispenser only

SAN Including dosing system for sanitizing product

DWI Insulation option for the tunnel only, dryer excluded. Shelf dryer can be insulated upon request. Recommended with HR10 – HR20 – HRP40

DRIVE Check voltage compatibility

BT Booster pump included

DIV For models RX 104, RX 104 E, RX 144, RX 144 E only splash guards removable

PI Available with 50 Hz frequency only. Not available for AS module

DVGW Not available with heat recovery or steam condenser
Components prescribed by DVGW on request (check option compatibility with the manufacturer)

XP In case of cold water supply for rinse (8-55 °C) and without any heat recovery, the extra power option is mandatory

With osmotic water supply and electrical conductivity lower than 200 microsiemens, it is mandatory to install a stainless steel heat exchanger

Peak-cut connect upon request

Warm water supply 55 °C

We recommend to install the machine in a well ventilated room, with a properly sized steam exhausting system

Option compatibility to be confirmed by the manufacturer after verification

OPTIONS

	DR64	DR69	DR94	DR99
Model	Dryer + 400 mm / 4,5 kW	Dryer + 400 mm / 9 kW	Dryer + 700 mm / 4,5 kW	Dryer + 700 mm / 9 kW
RX 104	€	€	€	€
RX 104 AS	€	€	€	€
RX 104 E *	€	€	€	€
RX 104 E AS	€	€	€	€
RX 144	€	€	€	€
RX 144 E	€	€	€	€
RX 184	€	€	€	€
RX 184 AS	€	€	€	€
RX 184 E	€	€	€	€
RX 184 E AS	€	€	€	€
RX 184 LC	€	€	€	€
RX 184 E LC	€	€	€	€
RX 244	€	€	€	€
RX 244 AS	€	€	€	€
RX 244 E *	€	€	€	€
RX 244 E AS	€	€	€	€

ID Recommended for DR69 - DR99. Not available for corner dryers

***** Construction according to UL-NSF standards upon request

DR64 - DR94 - DRA94MC - DRA184MC With the models RX 184 and RX 244. Verify with manufacturer

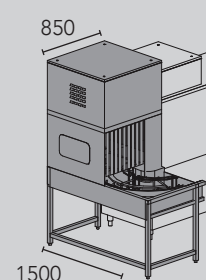
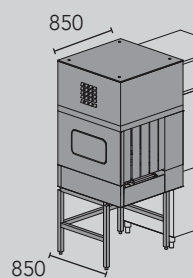
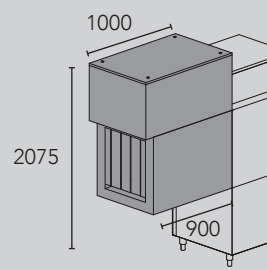
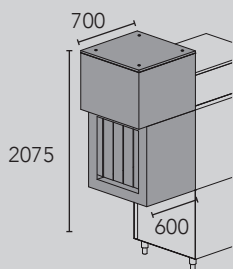

DR64 4,5 kW Electric
DR69 9 kW Electric
Dryer

DR94 4,5 kW Electric
DR99 9 kW Electric
Dryer

DRA94MC 4,5 kW Electric
DRA99MC 9 kW Electric
Dryer with mechanized arc 90° to be used with original DIHR racks only

DRA184MC 4,5 kW Electric
DRA189MC 9 kW Electric
Dryer with mechanized arc 180° to be used with original DIHR racks only

	DRA94MC	DRA99MC	DRA184MC	DRA189MC	ID
Model	Mechanized dryer 90° arc 4,5 kW	Mechanized dryer 90° arc 9 kW	Mechanized dryer 180° arc 4,5 kW	Mechanized dryer 180° arc 9 kW	Double skin Dryer
RX 104	€	€	€	€	€
RX 104 AS	€	€	€	€	€
RX 104 E *	€	€	€	€	€
RX 104 E AS	€	€	€	€	€
RX 144	€	€	€	€	€
RX 144 E	€	€	€	€	€
RX 184	€	€	€	€	€
RX 184 AS	€	€	€	€	€
RX 184 E	€	€	€	€	€
RX 184 E AS	€	€	€	€	€
RX 184 LC	€	€	€	€	€
RX 184 E LC	€	€	€	€	€
RX 244	€	€	€	€	€
RX 244 AS	€	€	€	€	€
RX 244 E *	€	€	€	€	€
RX 244 E AS	€	€	€	€	€

LC77/2 - LC77/3 Available on entry or exit connections, one per layout

DRA184MC - DRA189MC Mandatory division

DRA94MC - DRA99MC - DRA184MC - DRA189MC Available only without LC77/2 - LC77/3 on entry

AVAILABLE ARCS:

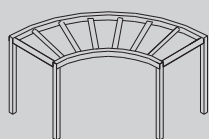

LC97 1300x1300x860 H
90° roller arc with tank

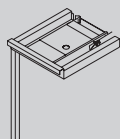



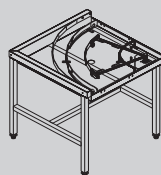

LC98 700x610x820 H
Angle loading table
complete with basket
pull-through system

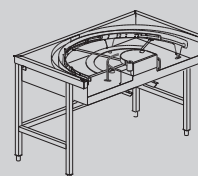

LC77/2 850x850x885 H
90° mechanized arc
(clockwise/counter-clockwise)
to be used with original DIHR
racks only

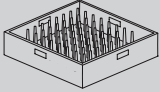
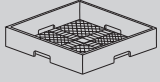
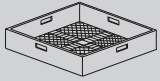
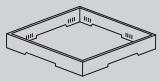

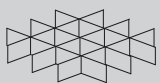
LC77/3 850x1500x885 H
180° mechanized arc
(clockwise/counter-clockwise)
to be used with original DIHR
racks only

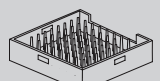
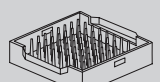
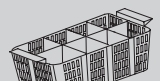
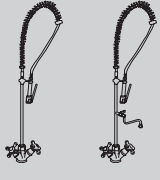
	Description	Capacity	Dimensions	Code
	PLATE BASKET	18 Plates	500x500x105 H	C 40
	NARROW MESH CUTLERY BASKET		500x500x106 H	C 41
	LARGE MESH BASKET	For glasses	500x500x105 H	C 44
	HOLDER FOR GLASS SUPPORT	For glass support (C112-C113-C114)	500x500x50 H	C 111
	GLASS SUPPORT	5x5 Glass Ø 87 mm (C 111)	500x500x50 H	C 112
	GLASS SUPPORT	4x4 Glass Ø 110 mm (C 111)	500x500x50 H	C 113
	GLASS SUPPORT	6x6 Glass Ø 72 mm (C 111)	500x500x50 H	C 114
	TRAYS BASKET	8 pcs max depth 25mm	500x500x105 H	C 43
	GASTRONORM TRAYS BASKET GN 1/1	6 pcs max depth 25mm	500x500x105 H	C 43/B
	CUTLERY BASKET		490x180x140 H	C 47
	FLEXIBLE SHOWER complete with mixing group and lever tap, to be fixed to the wall		1000 H	D 01
	FLEXIBLE SHOWER complete with mixing group and lever tap, to be fixed to the wall and intermediate tap		1000 H	D 02

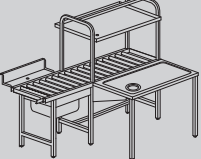
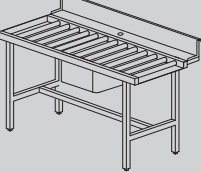
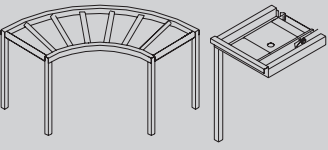
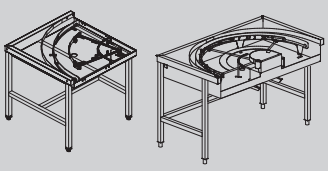
	Description	Capacity	Dimensions	Code	
	SHELF GRADING TABLE WITH RUBBER RING	Waste hole and special dimensions upon request	1515x620x660 H 2315x620x660 H 1600x1000x850 H 2400x1000x850 H	M 16* M 24* TC 16* TC 24*	
	MECHANIZED GRADING TABLE With mechanized basket advancement system	1 waste hole 2 waste holes	1800x1240 1525 H 2400x1240 1525 H	RTC 18* RTC 24*	
	Sink 500x400x270 H Sink 500x400x270 H	Standard rubber ring Standard rubber ring	1200x590x860 H 1200x730x860 H 1500x730x860 H 1800x730x860 H	T 35 T 55 T 80 T 90	
	ROLLER TABLE + sink, right or left version Sink 500x400x270 H		1600x730x860 H	T 195	
	LINEAR ROLLER TABLE WITH TANK	Option end microswitch	1100x650x860 H 1600x650x860 H 2100x650x860 H	LC 96/A* LC 96/B* LC 96/C* LC 95	
	LINEAR ROLLER TABLE WITH TANK complete with end microswitch	Not compatible with same references Not on 180° arcs To be connected to LC77/3 only and to dryer on 180°	1100x650x860 H 1600x650x860 H 1150x650x860 H 1650x650x860 H	LC 96/1 LC 96/1A LC 96/2 LC 96/2A	
	90° roller arc with tank (exit only with roller table) ANGLE LOADING TABLE complete with basket pull-through system	Option connection to prewash tables	1300x1300x860 H 700x610x820 H	LC 97* LC 98	
	90° mechanized arc clockwise/counter-clockwise, not available at the entry + LC version 180° mechanized arc (clockwise/counter-clockwise)	Available on entry or exit connections, one per layout. To be used with original DIHR racks only	850x850x885 H 850x1500x885 H	LC 77/2* LC 77/3*	

* Wooden cage +2% minimum + € / Special dimensions for tables upon request / Tables shown in right-to-left version

We strongly recommend the presence of a roller table with end microswitch at the exit of our rack-type machines for a correct operation



The DIHR rack-type dishwashers are the ideal answer for demanding customers such as restaurants, canteens, schools, hospitals, hotel of any size, cruise-liners, caterers and airports. Models equipped with reinforced double rinse on an independent module. Wash and rinse areas are completely separated, this avoids any interference between detergent and rinse aid, increasing its effectiveness and achieving a consequent reduction in consumption.

The wider distance between the pre-rinse arms also avoids the contamination in the rinse zone. Thanks to the renewed double rinsing system, we achieved a radical reduction of water consumption down to less than one liter per basket: far below the best market standards. This result, showing the green heart of the RX PRO line, allows significant savings on chemicals and electricity bills.



FEATURES

STANDARD

- SMART DRIVE advancement system with 5 speeds
- IPX5 electronic board
- TFT 5.7" display and soft touch keyboard
- Frequently used keys shortcut and menu language setting
- Constant monitoring of key operating parameters with integrated HACCP interface
- Alarms and events report
- ECO-DET Detergent economizer
- Reinforced double rinse 2R+, more effective and with limited consumptions
- 1-DRAIN Centralized drain
- Preset configuration to install our DIHR dispensers
- Water, energy consumptions and working time readout
- Preset maintenance reminder
- Possible working modes for dryer unit: all off, only fan or total power + fan (4,5 kW or 9 kW, maximum power according to the model)
- AISI 316 stainless steel tanks and boilers

OPTIONS

- Linear and 90°/180° corner drying modules, power 4,5 kW or 9 kW (double skin door available only for linear models) and steam dryer available
- Steam condenser (SC10) or 3 heat recovery systems, to be chosen according to the type of machine (XP included)
- Detergent dispenser with probe or dispensers kit
- Booster pump
- Hydraulic security system Break Tank
- Extra power for boiler
- Thermal and acoustic insulation
- Insulated tanks
- Stainless steel pumps
- Machine sanitization (with dedicated booster pump upon request)
- Delivery in 2 or more parts for easy handling
- CONNECTIVITY remote control compliant with the HACCP norms

CONNECTIVITY 4.0 & APP

WHEREVER YOU ARE...

YOUR DISHWASHER, JUST A CLICK AWAY

You will be constantly connected to the machine to monitor the work phases, review any eventual alarm and configure remotely the operating parameters according to your needs. Compliant with HACCP norms. Thanks to our brand new App, you will have access to connected machines and all commercial and technical documentation.

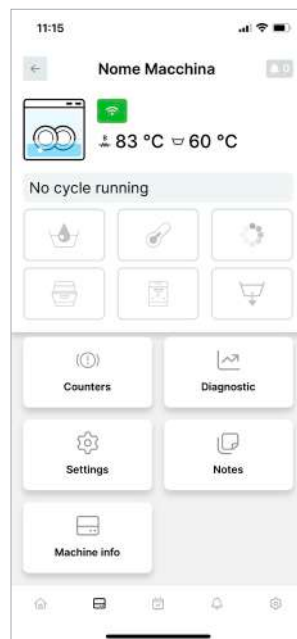

View all the working parameters and event records, working hours and any problem at any time.



In case of problem, the machine promptly alerts you. The technician can intervene remotely to solve the problem or anticipate the needed parts for an on-site intervention.



A daily activity report is available with all the events related to the dishwasher in a detailed spreadsheet with HACCP data.



Our Connectivity system is a revolutionary device limiting and facilitating the eventual intervention of a technician who can anticipate the necessary parts to be replaced, saving time and money.

AS OPTION

AUTOMATIC SHOWER WITH FILTER DRAWER EASY+

Time and energy savings are increased thanks to AS and EASY+, a combined and specific filtering device. Dishes will only need a superficial manual clearing and the automatic shower of the AS module will do a pre-treatment action. (Not available with an installed LC option).

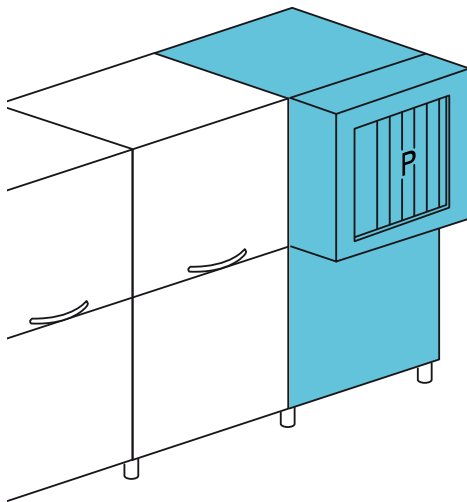
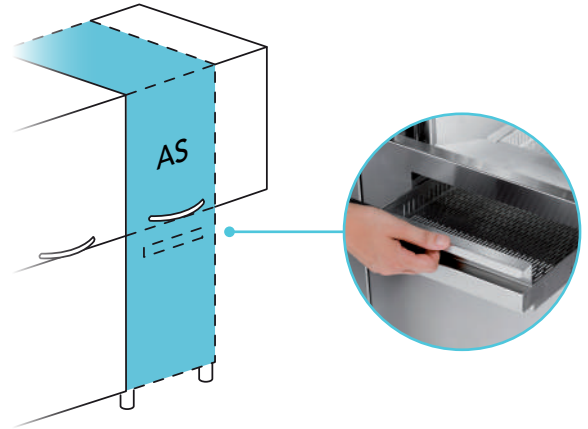

LC OPTION

90° CORNER PRE-WASH









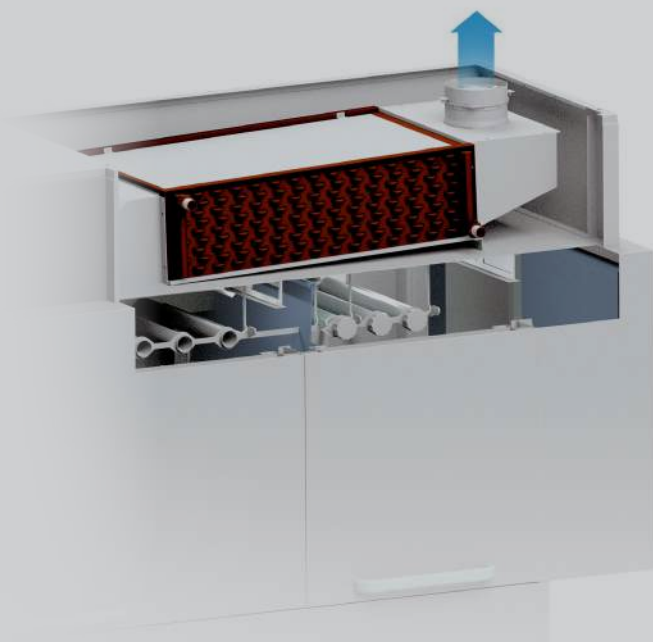

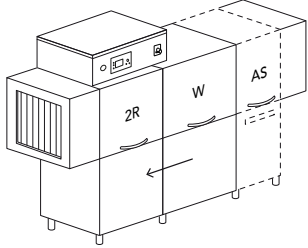

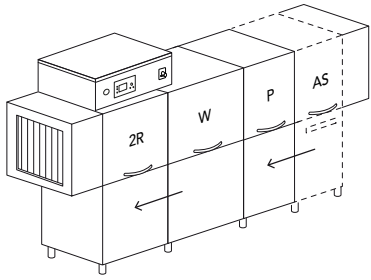

The design of our 90° corner pre-wash ensures the best solution taking up the minimal amount of space. Smaller dimensions, same productivity (Available on selected models and without AS option).

HEAT RECOVERY

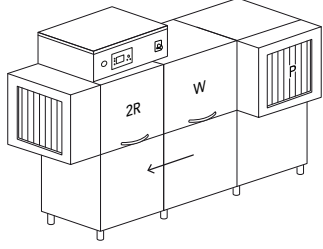
The heat recovery system allows to supply the machine with cold water*, ensuring at the same time significant savings in terms of energy consumptions. The steam produced by the machine in operation (otherwise dispersed in the working environment) is aspirated and condensed in the heat exchanger (air –water). The heat produced through this process is transferred to the inlet water, bringing it to a temperature of approximately 45 °C and reducing energy consumptions.

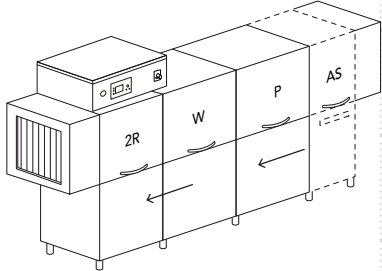
*inlet water temperature between 8 °C and 15 °C



Model		Voltage	Capacity	Dimensions	Code
RX 246	5 SPEEDS				
	RACK EQUIPMENT 1 X C40 1 X C43 1 X C44 1 X C47	400 V 3N ~ 50 Hz 20,68 kW	 Ø 450  500x500 100*/250 rack/h	2100x805 1830/2120 H 305 kg AS + 450 mm  530x325x25H	RX 246 RX 246 AS RX 246 V RX 246 AS V
RX 296	5 SPEEDS				
	RACK EQUIPMENT 1 X C40 1 X C43 1 X C44 1 X C47	400 V 3N ~ 50 Hz 21,58 kW	 Ø 450  500x500 135*/300 rack/h	2700x805 1830/2120 H 400 kg AS + 450 mm  530x325x25H	RX 296 RX 296 AS RX 296 V RX 296 AS V
RX 296 LC	5 SPEEDS AND CORNER PREWASH				
	RACK EQUIPMENT 1 X C40 1 X C43/B 1 X C44 1 X C47	400 V 3N ~ 50 Hz 21,58 kW	 Ø 450  500x500 135/300 rack/h	2425x985 1830/2120 H 400 kg GN 1/1 530x325x25H	RX 296 LC RX 296 LC V
RX 326	5 SPEEDS				
	RACK EQUIPMENT 1 X C40 1 X C43 1 X C44 1 X C47	400 V 3N ~ 50 Hz 25,86 kW	 Ø 450  500x500 150*/330 rack/h	3000x805 1830/2120 H 435 kg AS + 450 mm  530x325x25H	RX 326 RX 326 AS RX 326 V RX 326 AS V

Model	Voltage	Capacity	Dimensions	Code
RX 356 5 SPEEDS				
	400 V 3N ~ 50 Hz 37,26 kW	 Ø 450	3600x805 1830/2120 H 520 kg	RX 356
	400 V 3N ~ 50 Hz 5,76 kW 52 kg/h	 500x500 190*/360 rack/h	AS + 450 mm 530x325x25H	RX 356 AS
				RX 356 V
				RX 356 AS V
RX 356 LC 5 SPEEDS AND CORNER PREWASH				
	400 V 3N ~ 50 Hz 37,26 kW	 Ø 450	3325x985 1830/2120 H 520 kg	RX 356 LC
	400 V 3N ~ 50 Hz 5,76 kW 52 kg/h	 500x500 190*/360 rack/h	GN 1/1 530x325x25H	RX 356 LC V
				RX 356 LC V
RX 396 5 SPEEDS				
	400 V 3N ~ 50 Hz 40,04 kW	 Ø 450	3900x805 1830/2120 H 560 kg	RX 396
	400 V 3N ~ 50 Hz 7,04 kW 55 kg/h	 500x500 210*/400 rack/h	AS + 450 mm 530x325x25H	RX 396 AS
				RX 396 V
				RX 396 AS V

- V** Steam supply
- P** Prewash
- W** Wash
- 2R** Double reinforced rinse (pre-rinse + rinse on module)
- LC** Corner prewash
- AS** Automatic shower with filter drawer +450 mm
- *** Productivity according to DIN SPEC 10534 (contact time)

EAC label upon request

Option compatibility to be confirmed by the manufacturer after verification

OPTIONS

Model				PRE DOS	DDE-GROUP	DOS/S	SAN	PAP-SAN	DWI / T	DWI
	220-240 V 3 50 Hz	380-415 V 3N 50 Hz	60 Hz	DIHR disp. connections	Dispensers kit	Dispenser with probe	Sanitiz- ation	Booster pump Sanitization	Tanks insulation	Thermo- acoustic Insulation
RX 246	€	●	+ 3%	●	€	€	€	€	€	€
RX 246 V	€	●	+ 3%	●	€	€	€	€	€	€
RX 246 AS	€	●	+ 3%	●	€	€	€	€	€	€
RX 246 AS V	€	●	+ 3%	●	€	€	€	€	€	€
RX 296	€	●	+ 3%	●	€	€	€	€	€	€
RX 296 V	€	●	+ 3%	●	€	€	€	€	€	€
RX 296 AS	€	●	+ 3%	●	€	€	€	●	€	€
RX 296 AS V	€	●	+ 3%	●	€	€	€	●	€	€
RX 296 LC	€	●	+ 3%	●	€	€	€	€	€	€
RX 296 LC V	€	●	+ 3%	●	€	€	€	€	€	€
RX 326	€	●	+ 3%	●	€	€	€	€	€	€
RX 326 V	€	●	+ 3%	●	€	€	€	€	€	€
RX 326 AS	€	●	+ 3%	●	€	€	€	●	€	€
RX 326 AS V	€	●	+ 3%	●	€	€	€	●	€	€
RX 356	€	●	+ 3%	●	€	€	€	●	€	€
RX 356 V	€	●	+ 3%	●	€	€	€	●	€	€
RX 356 AS	€	●	+ 3%	●	€	€	€	●	€	€
RX 356 AS V	€	●	+ 3%	●	€	€	€	●	€	€
RX 356 LC	€	●	+ 3%	●	€	€	€	●	€	€
RX 356 LC V	€	●	+ 3%	●	€	€	€	●	€	€
RX 396	€	●	+ 3%	●	€	€	€	●	€	€
RX 396 V	€	●	+ 3%	●	€	€	€	●	€	€
RX 396 AS	€	●	+ 3%	●	€	€	€	●	€	€
RX 396 AS V	€	●	+ 3%	●	€	€	€	●	€	€

● Standard

--- Not available

DDE-GROUP Both detergent (with probe) and rinse-aid dispenser included

DOS/S For detergent dispenser only

SAN Including dosing system for sanitizing product

DWI Insulation option for the tunnel only, dryer excluded.
Shelf dryer can be insulated upon request

DWI - DWI/T Recommended with HR10 – HR20 – HRP40

DIV Compulsory for machines > 4,5m length

XP In case of cold water supply for rinse (8-55 °C) and without any heat recovery, the extra power option is mandatory

	PAP	BT	DVGW	XP	DIV	CONNECTIVITY	PI	SA	1-DRAIN	AUTOTIMER	ECO-DET	DRIVE
Model	Rinse Booster pump	Break Tank	DVGW	Extra Power	Price per division	CONNECTIVITY (HACCP)	S/S pumps	Automa- tized Drain	Centra- lized Drain	Auto- timer	Detergent economy- izer	Smart drive
RX 246	€	€	€	€	€	€	€	€	●	●	●	●
RX 246 V	€	€	€	€	€	€	€	----	●	●	●	●
RX 246 AS	€	€	€	€	€	€	€	€	●	●	●	●
RX 246 AS V	€	€	€	€	€	€	€	----	●	●	●	●
RX 296	€	€	€	€	€	€	€	€	●	●	●	●
RX 296 V	€	€	€	€	€	€	€	----	●	●	●	●
RX 296 AS	€	€	€	€	€	€	€	€	●	●	●	●
RX 296 AS V	€	€	€	€	€	€	€	----	●	●	●	●
RX 296 LC	€	€	€	€	€	€	€	€	●	●	●	●
RX 296 LC V	€	€	€	€	€	€	€	----	●	●	●	●
RX 326	€	€	€	€	€	€	€	€	●	●	●	●
RX 326 V	€	€	€	€	€	€	€	----	●	●	●	●
RX 326 AS	€	€	€	€	€	€	€	€	●	●	●	●
RX 326 AS V	€	€	€	€	€	€	€	----	●	●	●	●
RX 356	€	€	€	----	€	€	€	€	●	●	●	●
RX 356 V	€	€	€	----	€	€	€	----	●	●	●	●
RX 356 AS	€	€	€	----	€	€	€	€	●	●	●	●
RX 356 AS V	€	€	€	----	€	€	€	----	●	●	●	●
RX 356 LC	€	€	€	----	€	€	€	€	●	●	●	●
RX 356 LC V	€	€	€	----	€	€	€	----	●	●	●	●
RX 396	€	€	€	----	€	€	€	€	●	●	●	●
RX 396 V	€	€	€	----	€	€	€	----	●	●	●	●
RX 396 AS	€	€	€	----	€	€	€	€	●	●	●	●
RX 396 AS V	€	€	€	----	€	€	€	----	●	●	●	●

CONNECTIVITY Includes HACCP option. 10-year plan

PI Available with 50 Hz frequency only. Not available for AS module

DVGW Not available with heat recovery and steam condenser.
Components prescribed by DVGW on request (check option compatibility with the manufacturer).

BT Booster pump included

With osmotic water supply and electrical conductivity lower than 200 microsiemens, it is mandatory to install a stainless steel heat exchange

Warm water supply 55 °C

We recommend to install the machine in a well-ventilated room, with a properly sized steam exhausting system

Standard hints for scheduled maintenance and counters (working hours - water - energy)

Peak-cut connect upon request

OPTIONS

	SC10	HR10	HR20	HRP40	DR64	DR69	DR6V	DR94	DR99	DR9V
Model	Steam Condenser	Heat Recovery	Heat Recovery	Heat Recovery	Dryer + 400 mm / 4,5 kW	Dryer + 400 mm / 9 kW	Steam Dryer + 400 mm	Dryer + 700 mm / 4,5 kW	Dryer + 700 mm / 9 kW	Steam Dryer + 700 mm
RX 246 - RX 246 AS	€	€	----	€	€	€	----	€	€	----
RX 246 V - RX 246 AS V	€	€	----	€	----	----	€	----	----	€
RX 296 - RX 296 AS	€	€	€	€	€	€	----	€	€	----
RX 296 V - RX 296 AS V	€	€	€	€	----	----	€	----	----	€
RX 296 LC	€	€	€	€+	€	€	----	€	€	----
RX 296 LC V	€	€	€	€+	----	----	€	----	----	€
RX 326 - RX 326 AS	€	€	€	€	€	€	----	€	€	----
RX 326 V - RX 326 AS V	€	€	€	€	----	----	€	----	----	€
RX 356 - RX 356 AS	€	€	€	€	€	€	----	€	€	----
RX 356 V - RX 356 AS V	€	€	€	€	----	----	€	----	----	€
RX 356 LC	€	€	€	€+	€	€	----	€	€	----
RX 356 LC V	€	€	€	€+	----	----	€	----	----	€
RX 396 - RX 396 AS	€	€	€	€	€	€	----	€	€	----
RX 396 V - RX 396 AS V	€	€	€	€	----	----	€	----	----	€

+ Not available for LC version if the machine is next to the wall

ID Not available for corner dryers, recommended for DR69 - DR6V - DR99 - DR9V

HRP40 Available with 400 V 3N 50 Hz frequency only

HR20 In alternative HR10 or HRP40 HR10, HRP40. For the model RX 296 LC +50 mm length with installed HR20 and dryer

DRA184MT - DRA189MT Mandatory division

HR10-HR20-HRP40 In case of cold water supply for rinse (8-15 °C), we recommend to install the heat recovery system option

DR64 - DR94 - DRA94MT - DRA184MT Not recommended for models RX 296, RX 326, RX 356 and RX 396. Verify with manufacturer

Option compatibility to be confirmed by the manufacturer after verification

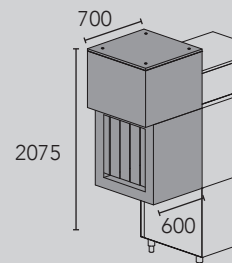
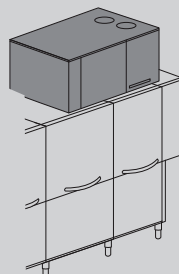
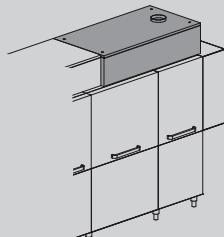
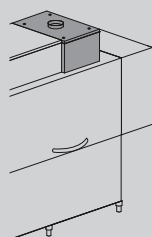
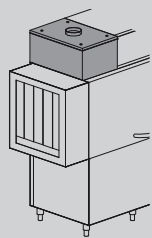

SC10

Steam condenser

HR10

Compact heat recovery

HR20

Heat recovery

HRP40

Heat recovery with heat pump

DR64

4,5 kW Electric

DR69

9 kW Electric

Dryer

DR69V

Steam dryer

Model	DRA94MT Motorized dryer 90° arc 4,5 kW	DRA99MT Motorized dryer 90° arc 9 kW	DRA9VMT Motorized steam dryer 90°arc	DRA184MT Motorized dryer 180° arc 4,5 kW	DRA189MT Motorized dryer 180° arc 9 kW	DRA18VMT Motorized steam dryer 180° arc	ID Double skin Dryer
RX 246 - RX 246 AS	€	€	---	€	€	---	€
RX 246 V - RX 246 AS V	---	---	€	---	---	€	€
RX 296 - RX 296 AS	€	€	---	€	€	---	€
RX 296 V - RX 296 AS V	---	---	€	---	---	€	€
RX 296 LC	€	€	---	€	€	---	€
RX 296 LC V	---	---	€	---	---	€	€
RX 326 - RX 326 AS	€	€	---	€	€	---	€
RX 326 V - RX 326 AS V	---	---	€	---	---	€	€
RX 356 - RX 356 AS	€	€	---	€	€	---	€
RX 356 V - RX 356 AS V	---	---	€	---	---	€	€
RX 356 LC	€	€	---	€	€	---	€
RX 356 LC V	---	---	€	---	---	€	€
RX 396 - RX 396 AS	€	€	---	€	€	---	€
RX 396 V - RX 396 AS V	---	---	€	---	---	€	€

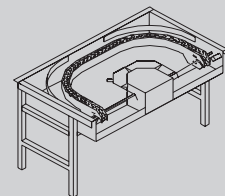
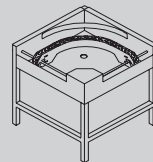
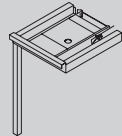
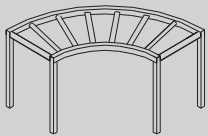
AVAILABLE ARCS:

LC97 1300x1300x860 H
90° roller arc with tank

LC98 700x610x820 H
Angle loading table complete
with basket pull-through system

LC97/2 850x850x885 H
90° motorized arc
(clockwise/counter-clockwise)

LC97/3 850x1500x885 H
180° motorized arc
(clockwise/counter-clockwise)

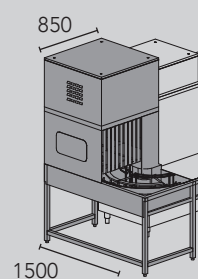
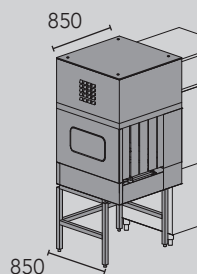
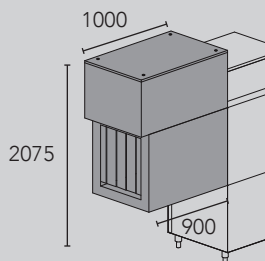

DR94 4,5 kW Electric
DR99 9 kW Electric
Dryer





DRA94MT 4,5 kW Electric
DRA99MT 9 kW Electric
Dryer with motorized arc 90°

DRA184MT 4,5 kW Electric
DRA189MT 9 kW Electric
Dryer with motorized arc 180°

DR9V
Steam dryer

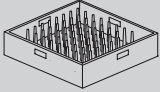
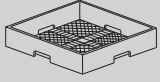
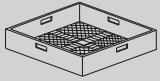
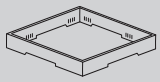
DRA9VMT
Steam dryer with motorized
arc 90°

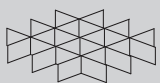
DRA18VMT
Steam dryer with motorized
arc 180°

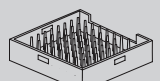
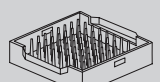
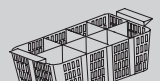
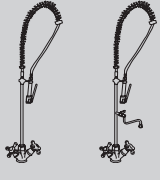
	Description	Capacity	Dimensions	Code
	PLATE BASKET	18 Plates	500x500x105 H	C 40
	NARROW MESH CUTLERY BASKET		500x500x106 H	C 41
	LARGE MESH BASKET	For glasses	500x500x105 H	C 44
	HOLDER FOR GLASS SUPPORT	For glass support (C112-C113-C114)	500x500x50 H	C111
	GLASS SUPPORT	5x5 Glass Ø 87 mm (C 111)	500x500x50 H	C 112
	GLASS SUPPORT	4x4 Glass Ø 110 mm (C 111)	500x500x50 H	C 113
	GLASS SUPPORT	6x6 Glass Ø 72 mm (C 111)	500x500x50 H	C 114
	TRAYS BASKET	8 pcs max depth 25mm	500x500x105 H	C 43
	GASTRONORM TRAYS BASKET GN 1/1	6 pcs max depth 25mm	500x500x105 H	C 43/B
	CUTLERY BASKET		490x180x140 H	C 47
	FLEXIBLE SHOWER complete with mixing group and lever tap, to be fixed to the wall		1000 H	D 01
	FLEXIBLE SHOWER complete with mixing group and lever tap, to be fixed to the wall and intermediate tap		1000 H	D 02

	Description	Capacity	Dimensions	Code
	SHELF		1515x620x660 H	M 16*
			2315x620x660 H	M 24*
	GRADING TABLE WITH RUBBER RING	Waste hole and special dimensions upon request	1600x1000x850 H	TC 16*
			2400x1000x850 H	TC 24*
	MECHANIZED GRADING TABLE With mechanized basket advancement system	1 waste hole	1800x1240 1525 H	RTC 18*
		2 waste holes	2400x1240 1525 H	RTC 24*
			1200x590x860 H	T 35
			1200x730x860 H	T 55
		Standard rubber ring	1500x730x860 H	T 80
		Standard rubber ring	1800x730x860 H	T 90
	Sink 500x400x270 H	Sink 500x400x270 H		
	ROLLER TABLE + sink, right or left version		1600x730x860 H	T 195
	Sink 500x400x270 H			
	LINEAR ROLLER TABLE WITH TANK		1100x650x860 H	LC 96/A*
			1600x650x860 H	LC 96/B*
			2100x650x860 H	LC 96/C*
		Option end microswitch		LC 95
	LC 96/1- LC 96/1A LC 96/2 - LC 96/2A	LINEAR ROLLER TABLE WITH TANK complete with end microswitch	1100x650x860 H	LC 96/1
			1600x650x860 H	LC 96/1A
			1150x650x860 H	LC 96/2
			1650x650x860 H	LC 96/2A
		Not compatible with same references Not on 180° arcs		
		To be connected to LC97/3 only and to dryer on 180°		
	90° roller arc with tank (exit only with roller table)		1300x1300x860 H	LC 97*
	ANGLE LOADING TABLE complete with basket pull-through system	Option connection to prewash tables	700x610x820 H	LC 98
	90° MOTORIZED ARC (clockwise/counter-clockwise)		850x850x885 H	LC 97/2*
	180° MOTORIZED ARC (clockwise/counter-clockwise)		850x1500x885 H	LC 97/3*

* Wooden cage +2% minimum + € / Special dimensions for tables upon request / Tables shown in right-to-left version

We strongly recommend the presence of a roller table with end microswitch at the exit of our rack-type machines for a correct operation



Thanks to the rack-type dishwashers of RX OPTIMA series, new efficiency goals are met. The 3R + three-step rinse system ensures considerable savings in terms of water consumption and unmatched quality results. The reduction of heat losses granted by walls thermal insulation, the heat recovered from the steam produced inside the machine (with optional HDR), are just some points of strength of this product range, whose main innovation is an important reduction of waste.

Their user-friendly design characterizes both the washing process and the daily cleaning and maintenance operations. The wide TFT screen makes the access to operating functions easy and comfortable. The IPX5 control panel, the rack-washing arms, the machine sanitization and the automatic drain options, make all the end of the day operations much more comfortable.



FEATURES

STANDARD

- TFT 5.7" display and soft touch keyboard
- IPX5 electronic board
- Easy-access frontal panel
- Constant monitoring of key operating parameters with integrated HACCP interface
- Detailed information and history of alarms in 6 languages
- Chemicals level management and related alerts/information
- SMART DRIVE+ advancement system with 10 speeds
- ECO-DET Detergent economizer
- Triple reinforced rinse 3R+ with adjustable water flow
- 1-DRAIN centralized drain
- Break Tank with integrated booster pump
- Thermal and acoustic insulation, insulated tanks
- Battery auto-cleaning for heat recovery system (if HDR option present)
- Control function for water, energy consumptions and working time
- Possible working modes for dryer unit: all off, only fan or total power + fan (4,5 kW or 9 kW, maximum power according to the model)
- Preset maintenance reminder
- AISI 316 stainless steel tanks and boilers

OPTIONS

- Automated tanks and boiler fill/drain through SA servovalves
- Detergent dispenser with probe or dispensers kit
- Extra power for boiler
- HDR200: insulated dryer + heat recovery system
- HDRA 209M and HDRA218M, insulated, on 90°/180° motorized chain conveyor
- Machine sanitization with dedicated booster pump
- Stainless steel pumps
- CONNECTIVITY remote control compliant with the HACCP norms

CONNECTIVITY 4.0 & APP

WHEREVER YOU ARE...

YOUR DISHWASHER, JUST A CLICK AWAY

You will be constantly connected to the machine to monitor the work phases, review any eventual alarm and configure remotely the operating parameters according to your needs. Compliant with HACCP norms. Thanks to our brand new App, you will have access to connected machines and all commercial and technical documentation.

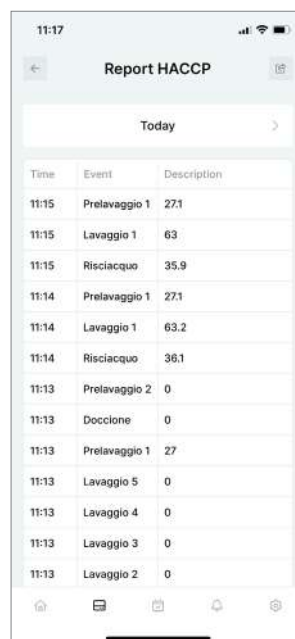
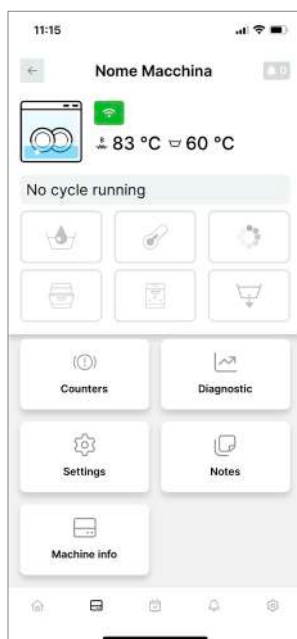

View all the working parameters and historical events, working hours and any problems at any time.



In case of problems, the machine promptly sends an email to you and to the technician who can intervene remotely to solve the problem or equip himself for on-site intervention.



The program allows you to remove an Excel file with all Haccp data at any time.



Discounts are provided for the purchase of 4.0 devices. You will be able to recover 40% of the cost of the car. Request more information to find out more.

AS OPTION

AUTOMATIC SHOWER WITH FILTER DRAWER EASY

Time and energy savings are increased thanks to AS and EASY+, a combined and specific filtering device. Dishes will only need a superficial manual clearing and the automatic shower of the AS module will do a pre-treatment action. (Not available with an installed LC option).

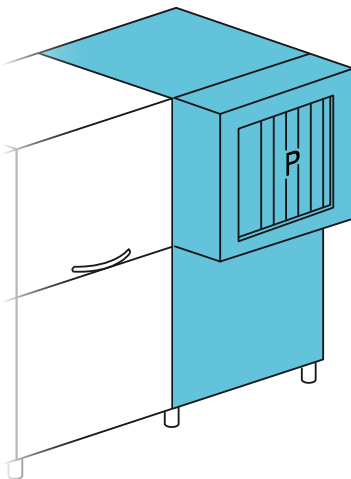
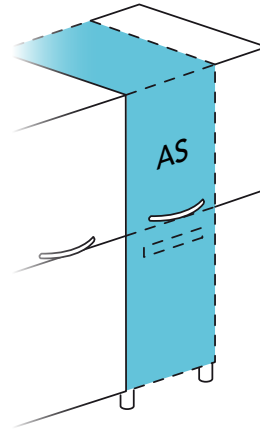

LC OPTION

90° CORNER PRE-WASH

The design of our 90° corner pre-wash ensures the best solution taking up the minimal amount of space. Smaller dimensions, same productivity (Available on selected models and without AS option).

HEAT RECOVERY





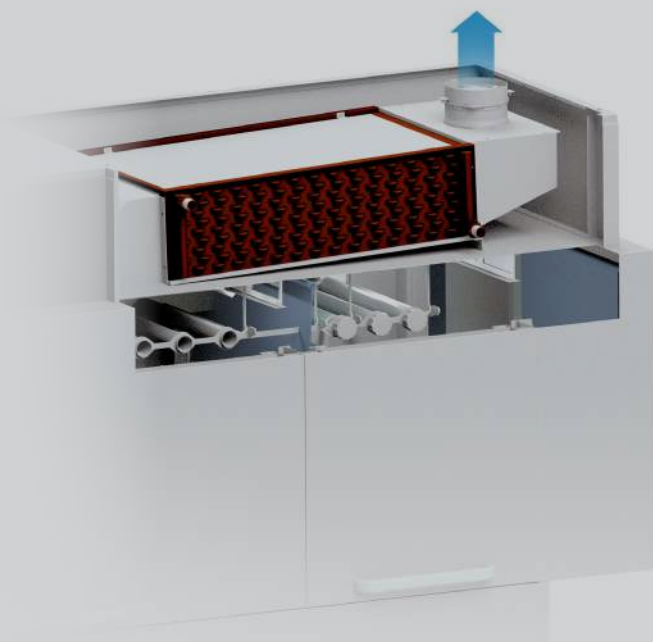





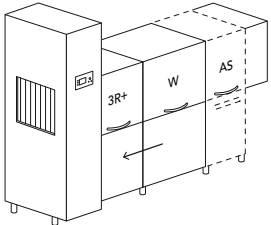



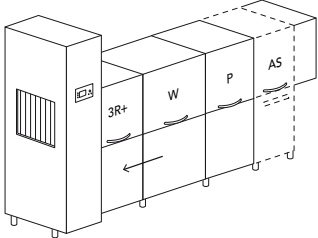

The heat recovery system allows to supply the machine with cold water*, ensuring at the same time significant savings in terms of energy consumptions. The steam produced by the machine in operation (otherwise dispersed in the working environment) is aspirated and condensed in the heat exchanger (air –water). The heat produced through this process is transferred to the inlet water, bringing it to a temperature of approximately 45 °C and reducing energy consumptions.

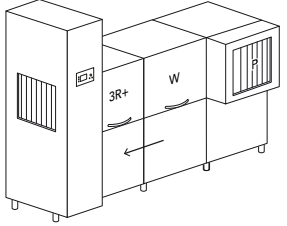
*inlet water temperature between 8 °C and 15 °C

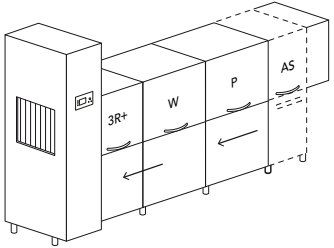

RX OPTIMA

RACK-TYPE DISHWASHERS
WITH 3R+ REINFORCED TRIPLE RINSE

Model		Voltage	Capacity	Dimensions	Code
RX 250	10 SPEEDS				
	<p>RACK EQUIPMENT</p> <ul style="list-style-type: none"> 1 x C40 1 x C43 1 x C44 1 x C47 	400 V 3N ~ 50 Hz 21,08 kW	 Ø 450  500x500 100*/250 rack/h	2250x920 2100/2120 H 350 kg AS + 450 mm  GN 1/1 530x325x25H	RX 250 RX 250 AS
RX 300	10 SPEEDS				
	<p>RACK EQUIPMENT</p> <ul style="list-style-type: none"> 1 x C40 1 x C43 1 x C44 1 x C47 	400 V 3N ~ 50 Hz 21,98 kW	 Ø 450  500x500 135*/300 rack/h	2850x920 2100/2120 H 510 kg AS + 450 mm  GN 1/1 530x325x25H	RX 300 RX 300 AS
RX 300 LC	10 SPEEDS - CORNER PREWASH				
	<p>RACK EQUIPMENT</p> <ul style="list-style-type: none"> 1 x C40 1 x C43/B 1 x C44 1 x C47 	400 V 3N ~ 50 Hz 21,98 kW	 Ø 450  500x500 135/300 rack/h	2575x985 2100/2120 H 510 kg  GN 1/1 530x325x25H	RX 300 LC
RX 330	10 SPEEDS				
	<p>RACK EQUIPMENT</p> <ul style="list-style-type: none"> 1 x C40 1 x C43 1 x C44 1 x C47 	400 V 3N ~ 50 Hz 26,26 kW	 Ø 450  500x500 150/330 rack/h	3150x920 2100/2120 H 550 kg AS + 450 mm  GN 1/1 530x325x25H	RX 330 RX 330 AS

Model	Voltage		Capacity	Dimensions	Code
RX 360	10 SPEEDS				
	RACK EQUIPMENT 1 x C40 1 x C43 1 x C44 1 x C47	400 V 3N ~ 50 Hz 37,66 kW	 Ø 450 500x500 190*/360 rack/h	3750x920 2100/2120 H 710 kg AS + 450 mm 530x325x25H	RX 360 RX 360 AS
RX 360 LC	10 SPEEDS				
	RACK EQUIPMENT 1 x C40 1 x C43/B 1 x C44 1 x C47	400 V 3N ~ 50 Hz 37,66 kW	 Ø 450 500x500 190*/360 rack/h	3475x985 2100/2120 H 710 kg 530x325x25H	RX 360 LC
RX 400	10 SPEEDS - CORNER PREWASH				
	RACK EQUIPMENT 1 x C40 1 x C43 1 x C44 1 x C47	400 V 3N ~ 50 Hz 40,44 kW	 Ø 450 500x500 210*/400 rack/h	4050x920 2100/2120 H 750 kg AS + 450 mm 530x325x25H	RX 400 RX 400 AS

- P** Prewash
- W** Wash
- 3R+** Triple reinforced rinse (double pre-rinse + rinse on module)
- LC** Corner prewash
- AS** Automatic shower with filter drawer + 450 mm
- *** Productivity according to DIN SPEC 10534 (contact time)

EAC label upon request

Option compatibility to be confirmed by the manufacturer after verification

OPTIONS

Model	220-240 V 3 50 Hz	380-415 V 3N 50 Hz	60 Hz	PRE DOS DIHR disp. connec- tions	DDE Dispensers kit	DOS/S Dispenser with Probe	SAN Sanitization	PAP-SAN Booster Pump Sanitization	DWI Thermoacoustic and Tank insulation	XP Extra Power
RX 250	€	●	+3%	●	€	€	€	€	●	€
RX 250 AS	€	●	+3%	●	€	€	€	€	●	€
RX 300	€	●	+3%	●	€	€	€	€	●	€
RX 300 AS	€	●	+3%	●	€	€	€	●	●	€
RX 300 LC	€	●	+3%	●	€	€	€	€	●	€
RX 330	€	●	+3%	●	€	€	€	€	●	€
RX 330 AS	€	●	+3%	●	€	€	€	●	●	€
RX 360	€	●	+3%	●	€	€	€	●	●	€
RX 360 AS	€	●	+3%	●	€	€	€	●	●	€
RX 360 LC	€	●	+3%	●	€	€	€	●	●	€
RX 400	€	●	+3%	●	€	€	€	●	●	€
RX 400 AS	€	●	+3%	●	€	€	€	●	●	€

- Standard
- DDE-GROUP** Both detergent (with probe) and rinse-aid dispenser included
- DOS/S** For detergent dispenser only
- SAN** Including dosing system for sanitizing product
- PAP-SAN** Supplied AS standard with sanitization option on models:
RX 300 AS, RX 330 AS, RX 360, RX 360 AS, RX 360 LC, RX 400, RX 400 AS
- DIV** Compulsory for machines > 4,5m length
- XP** In case of cold water supply for rinse (8-55 °C) and without any heat recovery, the extra power option is mandatory

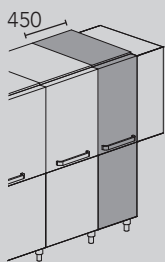

AS
Automatic Shower
with filter drawer

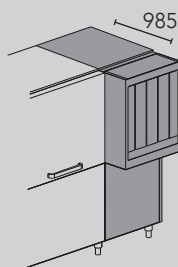

LC
Corner prewash

	DIV	CONNECTIVITY	PI	SA	1-DRAIN	AUTOTIMER	PAP	BT	DVGW	ECO-DET	DRIVE
Model	Price per division	CONNECTIVITY (HACCP)	S/S pumps	Automatic Drain	Centralized Drain	Autotimer	Rinse Booster pump	Break Tank	DVGW	Detergent saving system	Smart drive +
RX 250	€	€	€	€	●	●	●	●	€	●	●
RX 250 AS	€	€	€	€	●	●	●	●	€	●	●
RX 300	€	€	€	€	●	●	●	●	€	●	●
RX 300 AS	€	€	€	€	●	●	●	●	€	●	●
RX 300 LC	€	€	€	€	●	●	●	●	€	●	●
RX 330	€	€	€	€	●	●	●	●	€	●	●
RX 330 AS	€	€	€	€	●	●	●	●	€	●	●
RX 360	€	€	€	€	●	●	●	●	€	●	●
RX 360 AS	€	€	€	€	●	●	●	●	€	●	●
RX 360 LC	€	€	€	€	●	●	●	●	€	●	●
RX 400	€	€	€	€	●	●	●	●	€	●	●
RX 400 AS	€	€	€	€	●	●	●	●	€	●	●

CONNECTIVITY Includes HACCP option. 10-year plan

PI Available with 50 Hz frequency only. Not available for AS module

DVGW Not available with heat recovery and steam condenser
Components prescribed by DVGW on request (check option compatibility with the manufacturer)

In case of cold water supply for rinse (8-15 °C), we recommend to install the heat recovery system option

With osmotic water supply and electrical conductivity lower than 200 microsiemens, it is mandatory to install a stainless steel heat exchange

Warm water supply 55 °C

We recommend to install the machine in a well-ventilated room, with a properly sized steam exhausting system

Standard hints for scheduled maintenance and counters (working hours - water - energy)

Option compatibility to be confirmed by the manufacturer after verification

AVAILABLE ARCS:

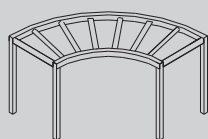

LC97 1300x1300x860 H
90° roller arc with tank

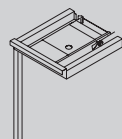

LC98 700x610x820 H
Angle loading table complete with basket pull-through system

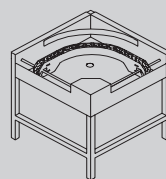

LC97/2 850x850x885 H
90° motorized arc (clockwise/counter-clockwise)

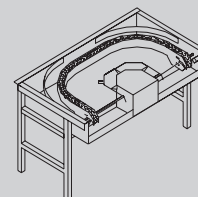

LC97/3 850x1500x885 H
180° motorized arc (clockwise/counter-clockwise)

OPTIONS

	LC30	SC10	SC15	HR15	HR20	HRP40
Model	Splash guard + 300 mm	Steam Condenser	Steam Condenser	Heat Recovery	Heat Recovery	Heat Recovery
RX 250	€	€	€	€	€	€
RX 250 AS	€	€	€	€	€	€
RX 300	€	€	€	€	€	€
RX 300 AS	€	€	€	€	€	€
RX 300 LC	€	€	€	€	€	€+
RX 330	€	€	€	€	€	€
RX 330 AS	€	€	€	€	€	€
RX 360	€	€	€	€	€	€
RX 360 AS	€	€	€	€	€	€
RX 360 LC	€	€	€	€	€	€+
RX 400	€	€	€	€	€	€
RX 400 AS	€	€	€	€	€	€

---- Not available

HDR 200 Dryer + heat recovery. Fully insulated device. In alternative, HDRA209M or HDRA218M

HDRA 209M Dryer + heat recovery on 90° motorized arc. Fully insulated device.
In alternative, HDR200 or HDRA218M

HDRA 218M Dryer + heat recovery on 180° motorized arc. Fully insulated device. In alternative, HDR200 or HDRA209M. Mandatory division.

+ Not available for LC version if the machine is next to the wall

In case of cold water supply for rinse (8-15 °C), we recommend to install the heat recovery system option

With osmotic water supply and electrical conductivity lower than 200 microsiemens, it is mandatory to install a stainless steel heat exchanger

Warm water supply 55 °C

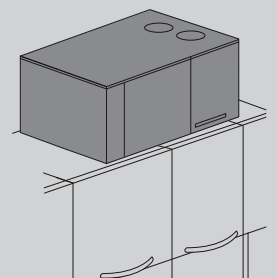
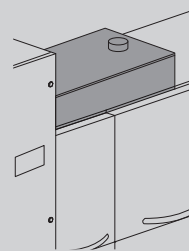
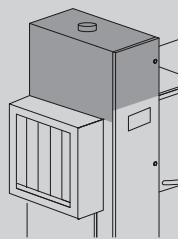
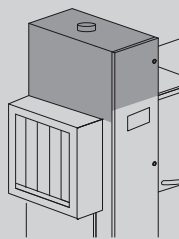
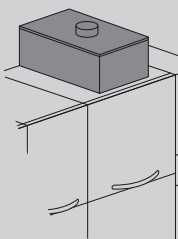

SC10

Steam condenser

SC15

Steam condenser

HR15

Compact heat recovery

HR20

Heat recovery

HRP40

Heat recovery with heat pump

	HDR200	HDRA209M	HDRA218M	DR204	DR209	DRA99MT	DRA189MT
Model	Dryer + Heat Recovery	Dryer + Heat Recovery	Dryer + Heat Recovery	Dryer	Insulated Dryer	Dryer with motorized arc 90°	Dryer with motorized arc 180°
RX 250	€	€	€	€	€	€	€
RX 250 AS	€	€	€	€	€	€	€
RX 300	€	€	€	€	€	€	€
RX 300 AS	€	€	€	€	€	€	€
RX 300 LC	€	€	€	€	€	€	€
RX 330	€	€	€	€	€	€	€
RX 330 AS	€	€	€	€	€	€	€
RX 360	€	€	€	€	€	€	€
RX 360 AS	€	€	€	€	€	€	€
RX 360 LC	€	€	€	€	€	€	€
RX 400	€	€	€	€	€	€	€
RX 400 AS	€	€	€	€	€	€	€

SC10 Available only with optional dryer

SC15 Not available with optional dryer

HR20 In alternative, HR 15, HRP 40

HRP40 Available with 400 V 3N 50 Hz frequency only

HR15-HR20-HRP40 In case of cold water supply for rinse (8-15 °C), we recommend to install the heat recovery system option

DR204 Not recommended for models RX 300, RX 330, RX 360 and RX 400, verify with manufacturer

DRA99MT - DRA189MT Mandatory division

Option compatibility to be confirmed by the manufacturer after verification

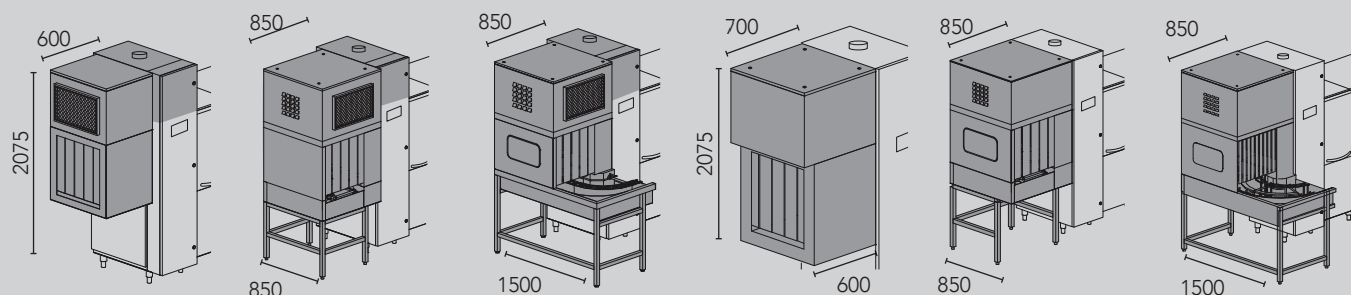

HDR 200 4,5kW
Electric Dryer
+ Heat Recovery





HDRA 209M 4,5kW
Electric Dryer
on 90° motorized arc
+ Heat Recovery

HDRA 218M 4,5kW
Electric Dryer
on 180° motorized
arc + Heat Recovery

DR204 4,5kW
DR209 9 kW
Insulated Dryer

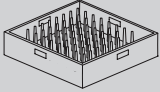
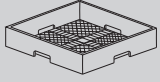
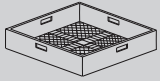
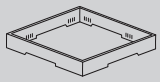
DRA99MT 9 kW
Dryer with motorized
arc 90°

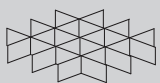
DRA189MT 9 kW
Dryer with motorized
arc 180°

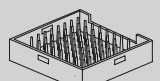
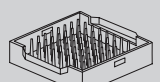
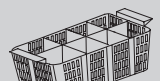
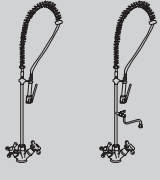
	Description	Capacity	Dimensions	Code
	PLATE BASKET	18 Plates	500x500x105 H	C 40
	NARROW MESH CUTLERY BASKET		500x500x106 H	C 41
	LARGE MESH BASKET	For glasses	500x500x105 H	C 44
	HOLDER FOR GLASS SUPPORT	For glass support (C112-C113-C114)	500x500x50 H	C111
	GLASS SUPPORT	5x5 Glass Ø 87 mm (C 111)	500x500x50 H	C 112
	GLASS SUPPORT	4x4 Glass Ø 110 mm (C 111)	500x500x50 H	C 113
	GLASS SUPPORT	6x6 Glass Ø 72 mm (C 111)	500x500x50 H	C 114
	TRAYS BASKET	8 pcs max depth 25mm	500x500x105 H	C 43
	GASTRONORM TRAYS BASKET	6 pcs max depth 25mm	500x500x105 H	C 43/B
	CUTLERY BASKET		490x180x140 H	C 47
	FLEXIBLE SHOWER complete with mixing group and lever tap, to be fixed to the wall		1000 H	D 01
	FLEXIBLE SHOWER complete with mixing group and lever tap, to be fixed to the wall and intermediate tap		1000 H	D 02

	Description	Capacity	Dimensions	Code
	SHELF		1515x620x660 H	M 16*
			2315x620x660 H	M 24*
	GRADING TABLE WITH RUBBER RING	Waste hole and special dimensions upon request	1600x1000x850 H	TC 16*
			2400x1000x850 H	TC 24*
	MECHANIZED GRADING TABLE With mechanized basket advancement system	1 waste hole	1800x1240 1525 H	RTC 18*
		2 waste holes	2400x1240 1525 H	RTC 24*
			1200x590x860 H	T 35
			1200x730x860 H	T 55
			1500x730x860 H	T 80
			1800x730x860 H	T 90
		Standard rubber ring		
		Standard rubber ring		
		Sink 500x400x270 H		
		Sink 500x400x270 H		
	ROLLER TABLE + sink, right or left version		1600x730x860 H	T 195
	Sink 500x400x270 H			
	LINEAR ROLLER TABLE WITH TANK		1100x650x860 H	LC 96/A*
			1600x650x860 H	LC 96/B*
			2100x650x860 H	LC 96/C*
		Option end microswitch		LC 95
	LINEAR ROLLER TABLE WITH TANK complete with end microswitch	Not compatible with same references Not on 180° arcs	1100x650x860 H	LC 96/1
		To be connected to LC97/3 only and to dryer on 180°	1600x650x860 H	LC 96/1A
			1150x650x860 H	LC 96/2
			1650x650x860 H	LC 96/2A
	90° roller arc with tank (exit only with roller table)		1300x1300x860 H	LC 97*
	ANGLE LOADING TABLE complete with basket pull-through system	Option connection to prewash tables	700x610x820 H	LC 98
	90° MOTORIZED ARC (clockwise/counter-clockwise)		850x850x885 H	LC 97/2*
	180° MOTORIZED ARC (clockwise/counter-clockwise)		850x1500x885 H	LC 97/3*

* Wooden cage +2% minimum + € / Special dimensions for tables upon request / Tables shown in right-to-left version

We strongly recommend the presence of a roller table with end microswitch at the exit of our rack-type machines for a correct operation



Big news at DIHR!

We are happy to introduce the “Green” QX PRO! This range has been enhanced and rewarded with the SMART LABEL HOST 2023 award for its functional efficiency. Thanks to innovative pre-rinse and rinse arms, we have achieved exceptional results while maintaining the same performance: 35% water savings compared to previous versions! Added to this innovation is the introduction of new options, including a renewed triple rinse, with osmotic water supply on request, and an improved drying system, which make them flexible, complete and first-class flight-type dishwashers. As you know, our goal is to minimize the use of

environmental resources but also your operating costs. Features such as the detergent economizer, the concept of thermal insulation, the CPF system and the double reinforced rinse show DIHR's wish to progress in the search for innovative solutions, ever more profitable and environmental friendly. As always, the DIHR flight-type dishwashers are available in multiple versions that can be combined with our other ranges (tray washers, rack conveyor dishwashers, transportation systems, etc). Our washing solutions, increasingly efficient over the years, adjust to different requirements while guaranteeing high hygiene standards to ensure optimal sanitation.

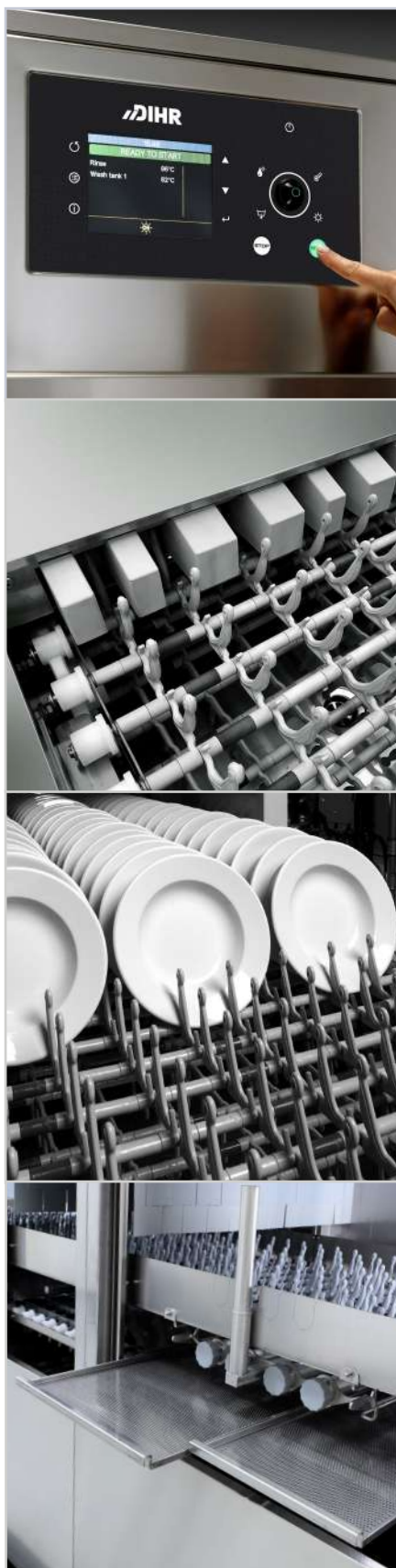

FEATURES

STANDARD

- SMART DRIVE 5 speed advancement system
- 710 mm wide conveyor
- Plates belt
- TFT 5.7" display and soft touch keyboard
- Frequently used keys shortcut and menu language setting
- Constant monitoring of key operations
- IPX5 electronic board
- Alarms and events report
- Autotimer
- Centralized 1-DRAIN and automatic AD drain, with total or partial emptying of the tanks
- Wash arms ALL-IN-1
- Use economizer
- ECO-DET Detergent economizer
- ACID PROOF Radial wash tanks in S/S AISI 316 inclined to provide complete drainage of the wash water
- S/S surface filters CLEAN+ to protect the wash tanks as well as the wash pump
- Double-skin, insulated and counterbalanced doors, equipped with anti-drop safety system
- THERMO BARRIER system for comfort in use
- Predisposition for DIHR rinse-aid and detergent dispensers connection
- Non return valve
- ACID PROOF stainless steel boilers in AISI 316, fully insulated to reduce thermal loss.
- Vertical self-cleaning pumps
-  Reinforced double rinse 2R+, improved efficiency with lower consumption
- CPF System: Controlled Pressure Flow
- Water, energy consumptions and working time control system
- Possible working modes for dryer unit: all off, only fan, half power 4,5 kW + fan, total power 9 kW + fan



FEATURES

OPTIONS

- Five different conveyor belts available, also with cutlery lane
- Different types of dryers: double skin dryer on module (with or without turboblowers) or on shelf (double skin on request)
- **NEW:** Double skin lateral dryer on shelf: innovative system with upper fan for improved drying results
- Steam condenser
- Three models of heat recovery to be chosen
- **NEW:** Triple reinforced rinse 3R+ for drastically reduced water consumption (with reverse osmosis water on separate module on request)
- AS6 Automatic shower with EASY+ with filter system
- Dispensers kit with peristaltic pump, for détergent as well as rinse-aid
- CONNECTIVITY remote control compliant with the HACCP norms (on request)
- Delivery in two or more parts, to ease installation operations
- Automatic self-cleaning of the machine available, with dedicated booster pump on request
- Tank insulation
- Break tank and booster pump
- Dedicated space for détergent and rinse-aid jugs
- S/S pumps
- Extra power in the boiler

STANDARD BELT

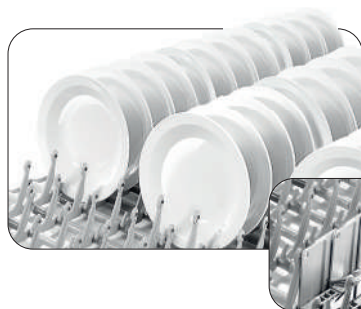

Standard belt for plates and optional cutlery lane

OPTIONAL BELT

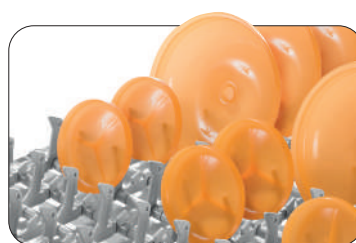

Special belt for hospitals



Standard belt for glasses



Special belt for thermal trays



Standard belt for trays and utensils

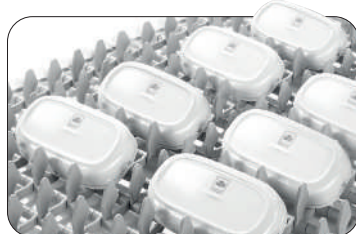

Special belt for in-flight catering

CONNECTIVITY 4.0 & APP

WHEREVER YOU ARE...
YOUR DISHWASHER, JUST A CLICK
AWAY

You will be constantly connected to the machine to monitor the work phases, review any eventual alarm and configure remotely the operating parameters according to your needs. Compliant with HACCP norms. Thanks to our brand new App, you will have access to connected machines and all commercial and technical documentation.

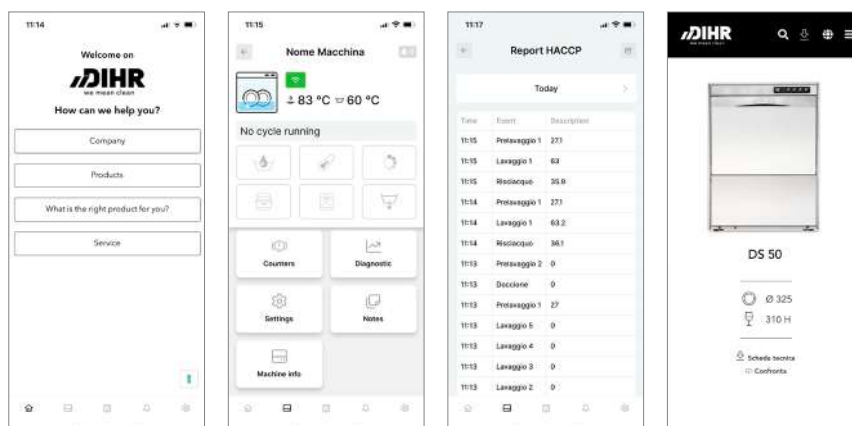

SMART LABEL HOST 2023 FOR FUNCTIONAL EFFICIENCY

According to the DIHR's sustainability vision and attention to customer operating costs, the QX range of flight conveyor dishwashers has been renewed. The result is a great reduction in water consumption: more than 35% when compared to the previous version, an important figure in today's environmental and economic needs. To do so, new rinse and pre-rinse arms and ramps have been designed to achieve one of the lowest consumption levels in our sector. With lower water, DIHR continues to ensure high quality rinsing results. Indeed, a higher washing pressure guarantees optimal results with the removal of all the chemicals present on the dishes. Such reduction of water also means significant savings in terms of detergent and energy, that have become very high expenditure items.



View all the working parameters and event records, working hours and any problem at any time.











In case of problem, the machine promptly alerts you. The technician can intervene remotely to solve the problem or anticipate the needed parts for an on-site intervention.

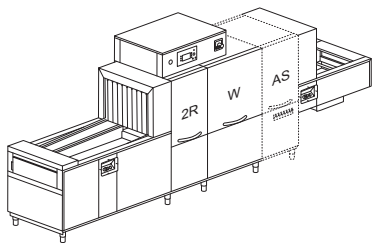

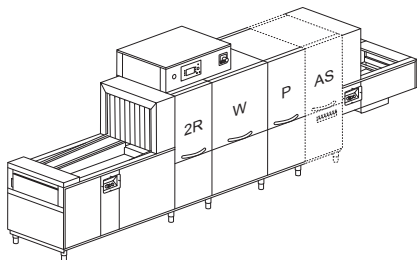

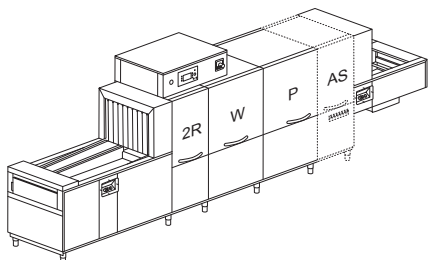

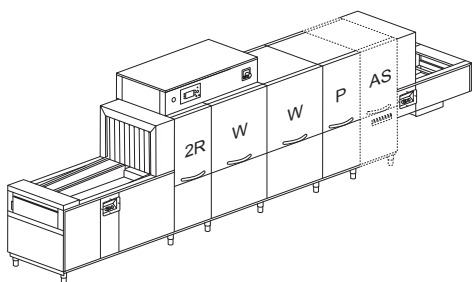

A daily activity report is available with all the events related to the dishwasher in a detailed spreadsheet with HACCP data.

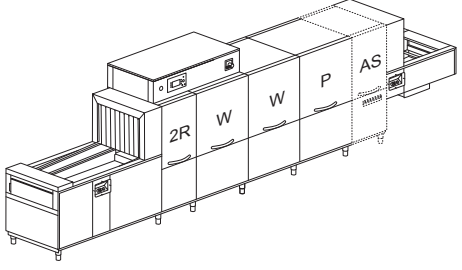

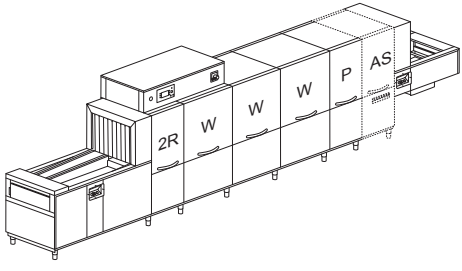
Our Connectivity system is a revolutionary device limiting and facilitating the eventual intervention of a technician who can anticipate the necessary parts to be replaced, saving time and money.

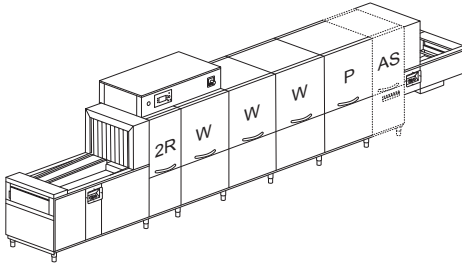
Model	Voltage	Capacity	Dimensions	Code
QX 246				
5 SPEEDS				
	400 V 3N ~ 50 Hz 27 kW	 450 H	4500x985 1860/2200H 595 kg	QX 246
	400 V 3N ~ 50 Hz 2,5 kW 17 kg/h	 710 1950/3690 dishes/h 2400* dishes/h		AS6 +600 mm
QX 376				
5 SPEEDS				
	400 V 3N ~ 50 Hz 29,45 kW	 450 H	5100x985 1860/2200H 730 kg	QX 376
	400 V 3N ~ 50 Hz 3,45 kW 20 kg/h	 710 2400/4050 dishes/h 3300* dishes/h		AS6 +600 mm
QX 416				
5 SPEEDS				
	400 V 3N ~ 50 Hz 33,5 kW	 450 H	5400x985 1860/2200H 745 kg	QX 416
	400 V 3N ~ 50 Hz 4,5 kW 25 kg/h	 710 3000/4800 dishes/h 3750* dishes/h		AS6 +600 mm
QX 536				
5 SPEEDS				
	400 V 3N ~ 50 Hz 49,45 kW	 450 H	6000x985x 860/2200H 880 kg	QX 536
	400 V 3N ~ 50 Hz 5,45 kW 29 kg/h	 710 4200/6450 dishes/h 4650* dishes/h		AS6 +600 mm

Model	Voltage	Capacity	Dimensions	Code
QX 596	5 SPEEDS			
	400 V 3N ~ 50 Hz 53,5 kW	 450 H  710	6300x985 1860/2200H 895 kg	QX 596
	400 V 3N ~ 50 Hz 6,5 kW 34 kg/h	4350/6750 dishes/h 5100* dishes/h	AS6 +600 mm	QX 596 AS6 QX 596 V
				QX 596 V AS6
QX 676	5 SPEEDS			
	400 V 3N ~ 50 Hz 69,45 kW	 450 H  710	7300x985 1860/2200H 1030 kg	QX 676
	400 V 3N ~ 50 Hz 7,45 kW 39 kg/h	5250/8100 dishes/h 6000* dishes/h	AS6 +600 mm	QX 676 AS6 QX 676 V
				QX 676 V AS6
QX 776	5 SPEEDS			
	400 V 3N ~ 50 Hz 72,5 kW	 450 H  710	7600x985 1860/2200H 1045 kg	QX 776
	400 V 3N ~ 50 Hz 8,5 kW 43 kg/h	5850/9000 dishes/h 6450* dishes/h	AS6 +600 mm	QX 776 AS6 QX 776 V
				QX 776 V AS6

- P** Prewash
- W** Wash
- 2R** Double reinforced rinse (pre-rinse + rinse on module)
- 3R+** Reinforced triple rinse with low water consumption: double pre-rinse + rinse on module (reverse osmosis on request)
- AS6** Automatic shower with filter drawer +600 mm
- V** Steam-heated
- *** Productivity according to DIN SPEC 10534 (contact time)

EAC label upon request

Option compatibility to be confirmed by the manufacturer after verification

OPTIONS

				AUTOTIMER	PRE DOS	DDE-GROUP	DOS/S	SAN
Model	220-240 V 3 50 Hz	380-415 V 3N 50 Hz	60 Hz	Autotimer	DIHR disp. connections	Dispensers kit	Dispenser with probe	Sanitization
QX 246	+ 2%	●	+ 3%	●	●	€	€	€
QX 246 AS6	+ 2%	●	+ 3%	●	●	€	€	€
QX 246 V	+ 1%	●	+ 3%	●	●	€	€	€
QX 246 V AS6	+ 1%	●	+ 3%	●	●	€	€	€
QX 376	+ 2%	●	+ 3%	●	●	€	€	€
QX 376 AS6	+ 2%	●	+ 3%	●	●	€	€	€
QX 376 V	+ 1%	●	+ 3%	●	●	€	€	€
QX 376 V AS6	+ 1%	●	+ 3%	●	●	€	€	€
QX 416	+ 2%	●	+ 3%	●	●	€	€	€
QX 416 AS6	+ 2%	●	+ 3%	●	●	€	€	€
QX 416 V	+ 1%	●	+ 3%	●	●	€	€	€
QX 416 V AS6	+ 1%	●	+ 3%	●	●	€	€	€
QX 536	+ 2%	●	+ 3%	●	●	€	€	€
QX 536 AS6	+ 2%	●	+ 3%	●	●	€	€	€
QX 536 V	+ 1%	●	+ 3%	●	●	€	€	€
QX 536 V AS6	+ 1%	●	+ 3%	●	●	€	€	€
QX 596	+ 2%	●	+ 3%	●	●	€	€	€
QX 596 AS6	+ 2%	●	+ 3%	●	●	€	€	€
QX 596 V	+ 1%	●	+ 3%	●	●	€	€	€
QX 596 V AS6	+ 1%	●	+ 3%	●	●	€	€	€
QX 676	+ 2%	●	+ 3%	●	●	€	€	€
QX 676 AS6	+ 2%	●	+ 3%	●	●	€	€	€
QX 676 V	+ 1%	●	+ 3%	●	●	€	€	€
QX 676 V AS6	+ 1%	●	+ 3%	●	●	€	€	€
QX 776	+ 2%	●	+ 3%	●	●	€	€	€
QX 776 AS6	+ 2%	●	+ 3%	●	●	€	€	€
QX 776 V	+ 1%	●	+ 3%	●	●	€	€	€
QX 776 V AS6	+ 1%	●	+ 3%	●	●	€	€	€

● Standard

□ Upon request

DDE-GROUP Both detergent (with probe) and rinse-aid dispensers included

DWI Insulation option for the tunnel only, dryer excluded. Shelf dryer can be double skin upon request

Peak-cut connect upon request

Warm water supply 55 °C

We recommend to install the machine in a well-ventilated room, with a properly sized steam exhausting system.

	PAP-SAN	DWI	DWI / T	CONNECTIVITY	XP	PAP	DRIVE
Model	Booster pump sanitization	Thermoacoustic insulation	Tanks insulation	CONNECTIVITY (HACCP)	Extra power	Booster pump	Smart drive
QX 246	€	€	€	€	€	€	●
QX 246 AS6	€	€	€	€	€	€	●
QX 246 V	€	€	€	€	□	€	●
QX 246 V AS6	€	€	€	€	□	€	●
QX 376	€	€	€	€	€	€	●
QX 376 AS6	●	€	€	€	€	€	●
QX 376 V	€	€	€	€	□	€	●
QX 376 V AS6	●	€	€	€	□	€	●
QX 416	€	€	€	€	€	€	●
QX 416 AS6	●	€	€	€	€	€	●
QX 416 V	€	€	€	€	□	€	●
QX 416 V AS6	●	€	€	€	□	€	●
QX 536	●	€	€	€	€	€	●
QX 536 AS6	●	€	€	€	€	€	●
QX 536 V	●	€	€	€	€	€	●
QX 536 V AS6	●	€	€	€	€	€	●
QX 596	●	€	€	€	€	€	●
QX 596 AS6	●	€	€	€	€	€	●
QX 596 V	●	€	€	€	€	€	●
QX 596 V AS6	●	€	€	€	€	€	●
QX 676	●	€	€	€	€	€	●
QX 676 AS6	●	€	€	€	€	€	●
QX 676 V	●	€	€	€	€	€	●
QX 676 V AS6	●	€	€	€	€	€	●
QX 776	●	€	€	€	€	€	●
QX 776 AS6	●	€	€	€	€	€	●
QX 776 V	●	€	€	€	□	€	●
QX 776 V AS6	●	€	€	€	□	€	●

DWI - DWI/T Recommended with HRF10 - HRF20 - HRPF40

CONNECTIVITY Includes HACCP option. 10-year plan

PAP-SAN One standard pump for models QX 536, QX 596, QX 676, QX 776

XP In case of cold water supply for rinse (8-55 °C) and without any heat recovery, the extra power option is mandatory.
 In case of cold water supply for rinse (8-15 °C), we recommend the heat recovery option.

Option compatibility to be confirmed by the manufacturer after verification

OPTIONS

Model	5 speeds	Master switch	Surface filters	Peak-cut for Dühr dosing	Estimated consumption readout	PI	1-DRAIN
QX 246	●	●	●	●	●	€	●
QX 246 AS6	●	●	●	●	●	€	●
QX 246 V	●	●	●	●	●	€	●
QX 246 V AS6	●	●	●	●	●	€	●
QX 376	●	●	●	●	●	€	●
QX 376 AS6	●	●	●	●	●	€	●
QX 376 V	●	●	●	●	●	€	●
QX 376 V AS6	●	●	●	●	●	€	●
QX 416	●	●	●	●	●	€	●
QX 416 AS6	●	●	●	●	●	€	●
QX 416 V	●	●	●	●	●	€	●
QX 416 V AS6	●	●	●	●	●	€	●
QX 536	●	●	●	●	●	€	●
QX 536 AS6	●	●	●	●	●	€	●
QX 536 V	●	●	●	●	●	€	●
QX 536 V AS6	●	●	●	●	●	€	●
QX 596	●	●	●	●	●	€	●
QX 596 AS6	●	●	●	●	●	€	●
QX 596 V	●	●	●	●	●	€	●
QX 596 V AS6	●	●	●	●	●	€	●
QX 676	●	●	●	●	●	€	●
QX 676 AS6	●	●	●	●	●	€	●
QX 676 V	●	●	●	●	●	€	●
QX 676 V AS6	●	●	●	●	●	€	●
QX 776	●	●	●	●	●	€	●
QX 776 AS6	●	●	●	●	●	€	●
QX 776 V	●	●	●	●	●	€	●
QX 776 V AS6	●	●	●	●	●	€	●

● Standard

---- Not available

LANE Only with DRF69 and DRF6V

DIV Compulsory for machines > 4,5 m length

BT Booster pump included

DVGW Not available with heat recovery and steam condenser
Components prescribed by DVGW on request (check option compatibility with the manufacturer)

	AD	ECO-DET	X-BELT	LANE	DIV	BT	DVGW
Model	Automatic drain	Chemicals saving system	Special belt	Cutlery lane	Price per division	Break tank	DVGW
QX 246	●	●	+ 7 %	----	€	€	€
QX 246 AS6	●	●	+ 7 %	----	€	€	€
QX 246 V	●	●	+ 7 %	----	€	€	€
QX 246 V AS6	●	●	+ 7 %	----	€	€	€
QX 376	●	●	+ 7 %	----	€	€	€
QX 376 AS6	●	●	+ 7 %	----	€	€	€
QX 376 V	●	●	+ 7 %	----	€	€	€
QX 376 V AS6	●	●	+ 7 %	----	€	€	€
QX 416	●	●	+ 7 %	+ 5 %	€	€	€
QX 416 AS6	●	●	+ 7 %	----	€	€	€
QX 416 V	●	●	+ 7 %	+ 5 %	€	€	€
QX 416 V AS6	●	●	+ 7 %	----	€	€	€
QX 536	●	●	+ 7 %	----	€	€	€
QX 536 AS6	●	●	+ 7 %	----	€	€	€
QX 536 V	●	●	+ 7 %	----	€	€	€
QX 536 V AS6	●	●	+ 7 %	----	€	€	€
QX 596	●	●	+ 7 %	+ 5 %	€	€	€
QX 596 AS6	●	●	+ 7 %	----	€	€	€
QX 596 V	●	●	+ 7 %	+ 5 %	€	€	€
QX 596 V AS6	●	●	+ 7 %	----	€	€	€
QX 676	●	●	+ 7 %	----	€	€	€
QX 676 AS6	●	●	+ 7 %	----	€	€	€
QX 676 V	●	●	+ 7 %	----	€	€	€
QX 676 V AS6	●	●	+ 7 %	----	€	€	€
QX 776	●	●	+ 7 %	+ 5 %	€	€	€
QX 776 AS6	●	●	+ 7 %	----	€	€	€
QX 776 V	●	●	+ 7 %	+ 5 %	€	€	€
QX 776 V AS6	●	●	+ 7 %	----	€	€	€

Option compatibility to be confirmed by the manufacturer after verification

OPTIONS

Model	NZ3 Neutral zone 300	NZ6 Neutral zone 600	NZH6 Neutral zone for dryer 600	DRF69 Shelf dryer	DRF6V Steam- heated shelf dryer	ID Double skin for shelf dryer	DRF70 Shelf dryer	DRF7V Steam- heated shelf dryer	DRF99M Stage dryer	DRF9VM Steam- heated stage dryer
QX 246 - QX 246 AS6	€	€	€	€	----	€	€	----	€	----
QX 246 V - QX 246 V AS6	€	€	€	€	€	€	€	€	€	€
QX 376 - QX 376 AS6	€	€	€	€	----	€	€	----	€	----
QX 376 V - QX 376 V AS6	€	€	€	€	€	€	€	€	€	€
QX 416 - QX 416 AS6	€	€	€	€	----	€	€	----	€	----
QX 416 V - QX 416 V AS6	€	€	€	€	€	€	€	€	€	€
QX 536 - QX 536 AS6	€	€	€	€	----	€	€	----	€	----
QX 536 V - QX 536 V AS6	€	€	€	€	€	€	€	€	€	€
QX 596 - QX 596 AS6	€	€	€	€	----	€	€	----	€	----
QX 596 V - QX 596 V AS6	€	€	€	€	€	€	€	€	€	€
QX 676 - QX 676 AS6	€	€	€	€	----	€	€	----	€	----
QX 676 V - QX 676 V AS6	€	€	€	€	€	€	€	€	€	€
QX 776 - QX 776 AS6	€	€	€	€	----	€	€	----	€	----
QX 776 V - QX 776 V AS6	€	€	€	€	€	€	€	€	€	€

---- Not available

* Available only with AS6

NZ3 Recommended with big quantities of trays to wash

NZ6 Recommended for big quantities of trays to wash. Module equipped with a front door

NZH6 Recommended with dryers with blowers

ID Recommended option for DRF69 and DRF6V. Only for shelf dryer

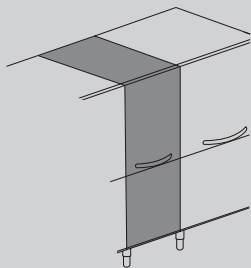

NZ3 + 300 mm
Neutral zone

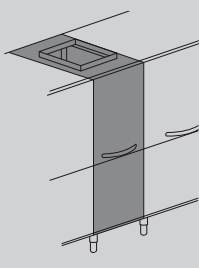

NZ6 + 600 mm
Neutral zone with door

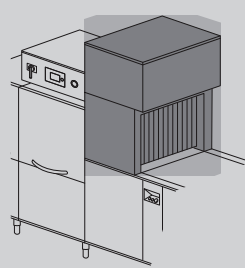

DRF69 9 kW
Shelf dryer

DRF6V
Steam heated shelf dryer

DRF70
Double skin lateral shelf dryer with upper fan

DRF7V
Steam-heated double skin shelf lateral dryer with upper fan

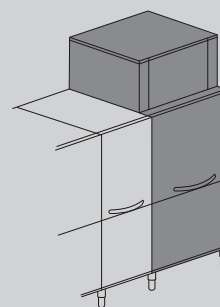

DRF99M
+ 900 mm - 9 kW
Dryer module

DRF9VM + 900 mm
Steam heated dryer module

	DRF99MB	DRF9VMB	SCF10	HRF10	HRF20	HRPF40	3R+	3R+ RO	STOCK
Model	Stage dryer with blowers	Steam-heated stage dryer with blowers	Steam condenser	Heat recovery	Heat recovery	Heat recovery	Triple reinforced rinse	Triple reinforced rinse with RO	Chemicals compartment
QX 246 - QX 246 AS6	€	----	€	€	€ *	€ *	€	€	€
QX 246 V - QX 246 V AS6	€	€	€	€	€ *	€ *	€	€	€
QX 376 - QX 376 AS6	€	----	€	€	€	€	€	€	€
QX 376 V - QX 376 V AS6	€	€	€	€	€	€	€	€	€
QX 416 - QX 416 AS6	€	----	€	€	€	€	€	€	€
QX 416 V - QX 416 V AS6	€	€	€	€	€	€	€	€	€
QX 536 - QX 536 AS6	€	----	€	€	€	€	€	€	€
QX 536 V - QX 536 V AS6	€	€	€	€	€	€	€	€	€
QX 596 - QX 596 AS6	€	----	€	€	€	€	€	€	€
QX 596 V - QX 596 V AS6	€	€	€	€	€	€	€	€	€
QX 676 - QX 676 AS6	€	----	€	€	€	€	€	€	€
QX 676 V - QX 676 V AS6	€	€	€	€	€	€	€	€	€
QX 776 - QX 776 AS6	€	----	€	€	€	€	€	€	€
QX 776 V - QX 776 V AS6	€	€	€	€	€	€	€	€	€

DRF99M - DRF9VM Module with front door

HRF10 - HRF20 - HRPF40 In case of cold water supply for rinse (8-15 °C), we recommend to install the optional heat recovery system

3R+ Reinforced triple rinse: Improved consumptions (with reverse osmosis water on request).

With osmotic water supply osmotic water supply and electrical conductivity lower than 200 microsiemens, it is mandatory to install a stainless steel heat exchanger

Option compatibility to be confirmed by the manufacturer after verification.

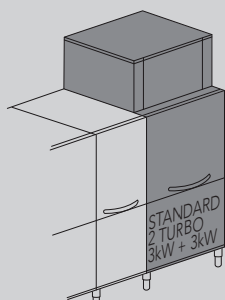

DRF99MB + 900 mm - 15 kW
Dryer module

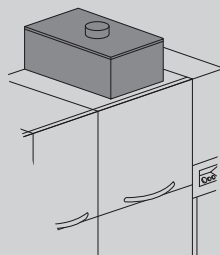

DRF9VMB + 900 mm
Steam heated dryer module

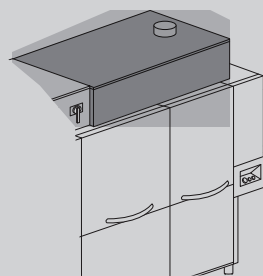

HRF10
Compact heat recovery

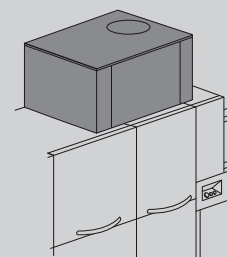

HRF20
Heat recovery

HRPF40
Heat recovery with heat pump

SCF10
Steam condenser

OPTIONS

	MI900	MI1200	MIS1200	MI1500	MI1800	MI2200	MIR2200
Model	Entry mod. 900	Entry mod. 1200	Over. entry mod. 1200	Entry mod. 1500	Entry mod. 1800	Entry mod. 2200	Lowered belt entry mod. 2200
QX 246 - QX 246 AS6	€	€	●	€	€	€	€
QX 246 V - QX 246 V AS6	€	€	●	€	€	€	€
QX 376 - QX 376 AS6	€	€	●	€	€	€	€
QX 376 V - QX 376 V AS6	€	€	●	€	€	€	€
QX 416 - QX 416 AS6	€	€	●	€	€	€	€
QX 416 V - QX 416 V AS6	€	€	●	€	€	€	€
QX 536 - QX 536 AS6	€	€	●	€	€	€	€
QX 536 V - QX 536 V AS6	€	€	●	€	€	€	€
QX 596 - QX 596 AS6	€	€	●	€	€	€	€
QX 596 V - QX 596 V AS6	€	€	●	€	€	€	€
QX 676 - QX 676 AS6	€	€	●	€	€	€	€
QX 676 V - QX 676 V AS6	€	€	●	€	€	€	€
QX 776 - QX 776 AS6	€	€	●	€	€	€	€
QX 776 V - QX 776 V AS6	€	€	●	€	€	€	€

- Standard
- Upon request
- Not available

Option compatibility to be confirmed by the manufacturer after verification

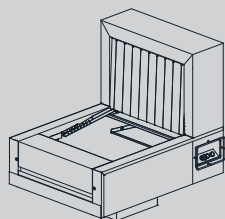

Overhanging entry module

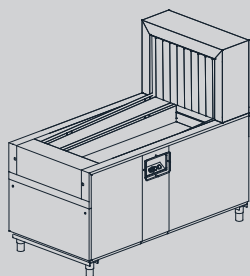

Entry module

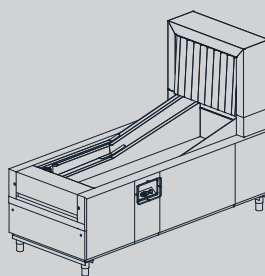

Lowered belt entry module

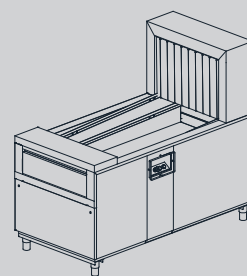

Exit module

	MI2700	MIR2700	EM900	EM1200	EM1500	EM1800	EM2200	EM2700
Model	Entry mod. 2700	Lowered belt entry mod. 2700	Exit mod. 900	Exit mod. 1200	Exit mod. 1500	Exit mod. 1800	Exit mod. 2200	Exit mod. 2700
QX 246 - QX 246 AS6	€	€	□	□	□	●	€	€
QX 246 V - QX 246 V AS6	€	€	□	□	□	●	€	€
QX 376 - QX 376 AS6	€	€	□	□	□	●	€	€
QX 376 V - QX 376 V AS6	€	€	□	□	□	●	€	€
QX 416 - QX 416 AS6	€	€	□	□	□	●	€	€
QX 416 V - QX 416 V AS6	€	€	□	□	□	●	€	€
QX 536 - QX 536 AS6	€	€	□	□	□	●	€	€
QX 536 V - QX 536 V AS6	€	€	□	□	□	●	€	€
QX 596 - QX 596 AS6	€	€	□	□	□	●	€	€
QX 596 V - QX 596 V AS6	€	€	□	□	□	●	€	€
QX 676 - QX 676 AS6	€	€	□	□	□	□	●	€
QX 676 V - QX 676 V AS6	€	€	□	□	□	□	●	€
QX 776 - QX 776 AS6	€	€	□	□	□	□	●	€
QX 776 V - QX 776 V AS6	€	€	□	□	□	□	●	€

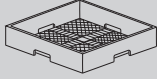
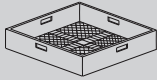
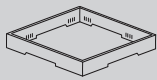
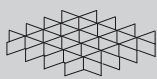
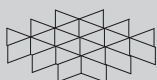
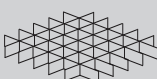
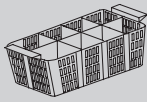
	Description	Capacity	Dimensions	Code	
	NARROW MESH CUTLERY BASKET		500x500x106 H	C 41	
	LARGE MESH BASKET	For glasses	500x500x105 H	C 44	
	HOLDER FOR GLASS SUPPORT	For glass support (C112-C113-C114)	500x500x50 H	C111	
	GLASS SUPPORT	5x5 Glass Ø 87 mm (C 111)	500x500x50 H	C 112	
	GLASS SUPPORT	4x4 Glass Ø 110 mm (C 111)	500x500x50 H	C 113	
	GLASS SUPPORT	6x6 Glass Ø 72 mm (C 111)	500x500x50 H	C 114	
	CUTLERY BASKET		490x180x140 H	C 47	



You deserve the best. With the new QX OPTIMA "Green", you will have it!

This range has been enhanced and rewarded with the SMART LABEL HOST 2023 award for its functional efficiency. Thanks to innovative pre-rinse and rinse arms, we have achieved exceptional results while maintaining the same performance: 35% water savings compared to previous versions! Added to this innovation is the introduction of new options, including a renewed triple rinse with osmotic water and an improved drying system, which make them flexible, complete and first-class flight-type dishwashers. Let us not forget that DIHR's vision is to minimize the use of envi-

ronmental resources but also your operating costs. Features such as the detergent economizer, the concept of thermal insulation, the CPF system and the double reinforced rinse show DIHR's wish to progress in the search for innovative solutions, ever more profitable and environmental friendly. Unique systems like HDRF make the machine energy self-sufficient and cost effective. Finally, the communication experience with the machine has been revolutionized thanks to the brand new Connectivity remote interaction system, available on all electronic devices and on the brand new DIHR App. Everything is under control in the blink of an eye!

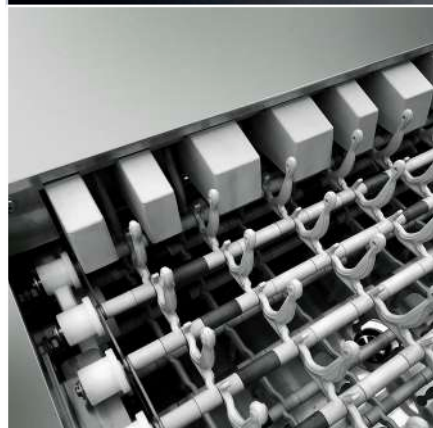

FEATURES

STANDARD

- SMART DRIVE+ 10 speed advancement system
- 710 mm wide conveyor
- Plates belt
- TFT 5.7" display and soft touch keyboard
- Frequently used keys shortcut and menu language setting
- Constant monitoring of key operations
- IPX5 electronic board
- Alarms and events report
- Autotimer
- Break Tank system
- Centralized 1-DRAIN and automatic AD drain, with total or partial emptying of the tanks
- Wash arms ALL-IN-1
- Use economizer
- ECO-DET Detergent economizer
- Thermal and acoustic insulation of both the machine and tanks
- ACID PROOF Radial wash tanks in S/S AISI 316 inclined to provide complete drainage of the wash water
- S/S surface filters CLEAN+ to protect the wash tanks as well as the wash pump
- Double-skin, insulated and counterbalanced doors, equipped with anti-drop safety system
- THERMO BARRIER system for comfort in use
- Predisposition for DIHR rinse-aid and detergent dispensers connection
- ACID PROOF stainless steel boilers in AISI 316, fully insulated to reduce thermal loss.
- Vertical self-cleaning pumps
- Booster pump
- 🌿 Reinforced triple rinse 3R+ : improved consumptions (reverse osmosis on request)
- CPF System: Controlled Pressure Flow
- Water, energy consumptions and working time control system
- Possible working modes for dryer unit: all off, only fan, half power 4,5 kW + fan, total power 9 kW + fan



FEATURES

OPTIONS

- Five different conveyor belts available, also with cutlery lane
- Different types of dryers: double skin dryer on module (with or without turboblowers) or on shelf
- **NEW:** double skin lateral dryer on shelf: innovative system with upper fan for improved drying results
- Two types of steam condensers available
- Three models of heat recovery to be chosen
- HDRF: patented insulated linear system of dryer and heat recovery Steam-heated system available. Self-cleaning of the heat exchanger included"
- **NEW:** triple reinforced rinse 3R+ con reverse osmotic water on a separate module
- AS6 Automatic shower with EASY+ with filter system
- Dispensers kit with peristaltic pump, for detergent as well as rinse-aid
- CONNECTIVITY remote control compliant with the HACCP norms (on request)
- Delivery in two or more parts, to ease installation operations
- Automatic self-cleaning of the machine available, with dedicated booster pump on request
- STOCK: Dedicated space for detergent and rinse-aid jugs
- S/S pumps
- Extra power in the boiler

STANDARD BELTS

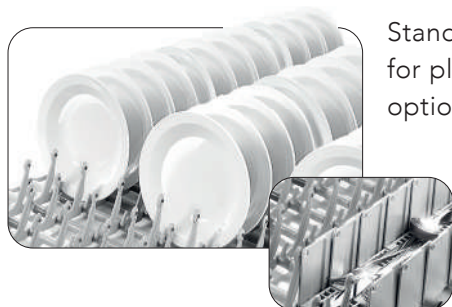

Standard belt for plates and optional cutlery lane



Standard belt for glasses



Standard belt for trays and utensils

OPTIONAL BELTS

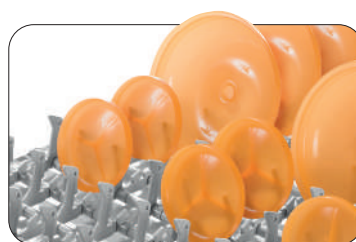

Special belt for hospitals



Special belt for thermal trays



Special belt for in-flight catering

CONNECTIVITY 4.0 & APP

WHEREVER YOU ARE...
YOUR DISHWASHER, JUST A CLICK AWAY

You will be constantly connected to the machine to monitor the work phases, review any eventual alarm and configure remotely the operating parameters according to your needs. Compliant with HACCP norms. Thanks to our brand new App, you will have access to connected machines and all commercial and technical documentation.

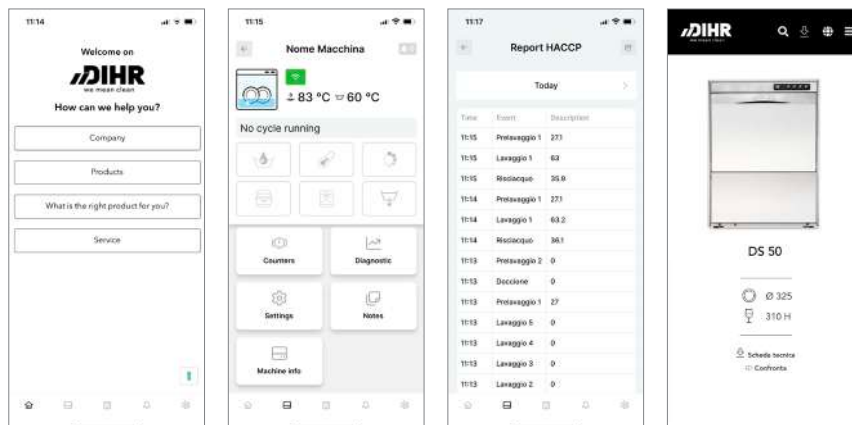

SMART LABEL HOST 2023 FOR FUNCTIONAL EFFICIENCY

According to the DIHR's sustainability vision and attention to customer operating costs, the QX range of flight conveyor dishwashers has been renewed. The result is a great reduction in water consumption: more than 35% when compared to the previous version, an important figure in today's environmental and economic needs. To do so, new rinse and pre-rinse arms and ramps have been designed to achieve one of the lowest consumption levels in our sector. With lower water, DIHR continues to ensure high quality rinsing results. Indeed, a higher washing pressure guarantees optimal results with the removal of all the chemicals present on the dishes. Such reduction of water also means significant savings in terms of detergent and energy, that have become very high expenditure items.



View all the working parameters and historical events, working hours and any problems at any time.











In case of problems, the machine promptly sends an email to you and to the technician who can intervene remotely to solve the problem or equip himself for on-site intervention.

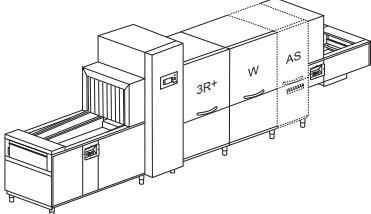

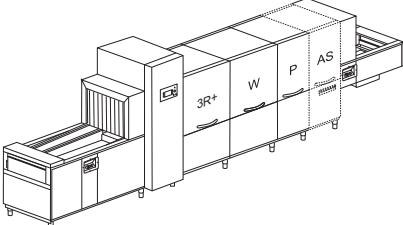
The program allows you to remove an Excel file with all Haccp data at any time.

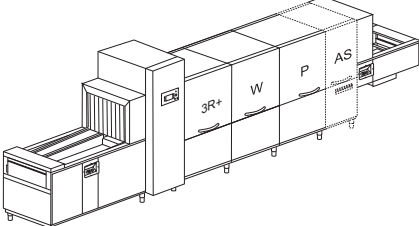

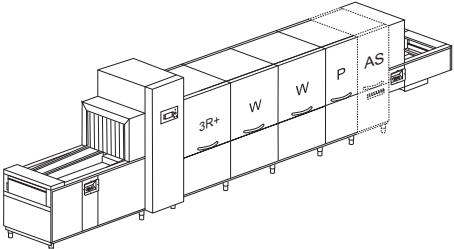
Discounts are provided for the purchase of 4.0 devices. You will be able to recover 40% of the cost of the car. Request more information to find out more.

Model	Voltage	Capacity	Dimensions	Code
QX 250				
10 SPEEDS				
	400 V 3N ~ 50 Hz 27,75 kW	450 H	5500x1110 2070/2200H 715 kg	QX 250
		 710		QX 250 AS6
	400 V 3N ~ 50 Hz 3,25 kW 17 kg/h	1950/3690 dishes/h	AS6 +600 mm	QX 250 V
		2850* dishes/h		QX 250 V AS6
QX 380				
10 SPEEDS				
	400 V 3N ~ 50 Hz 30,2 kW	450 H	6100x1110 2070/2200H 850 kg	QX 380
		 710		QX 380 AS6
	400 V 3N ~ 50 Hz 4,2 kW 20 kg/h	2400/4050 dishes/h	AS6 +600 mm	QX 380 V
		3660* dishes/h		QX 380 V AS6
QX 420				
10 SPEEDS				
	400 V 3N ~ 50 Hz 34,25 kW	450 H	6400x1110 2070/2200H 865 kg	QX 420
		 710		QX 420 AS6
	400 V3N ~ 50 Hz 5,25 kW 25 kg/h	3000/4800 dishes/h	AS6 +600 mm	QX 420 V
		4200* dishes/h		QX 420 V AS6
QX 540				
10 SPEEDS				
	400 V3N ~ 50 Hz 50,2 kW	450 H	7000x1110 2070/2200H 1000 kg	QX 540
		 710		QX 540 AS6
	400 V 3N ~ 50 Hz 6,2 kW 29 kg/h	4200/6450 dishes/h	AS6 +600 mm	QX 540 V
		5100* dishes/h		QX 540 V AS6

Model	Voltage	Capacity	Dimensions	Code
QX 600				
10 SPEEDS				
	400 V 3N ~ 50 Hz 51,25 kW	 450 H 710	7300x1110 2070/2200H 1015 kg	QX 600
	400 V 3N ~ 50 Hz 7,25 kW 29 kg/h	4350/6750 dishes/h 5550* dishes/h	AS6 +600 mm	QX 600 AS6 QX 600 V QX 600 V AS6
	QX 680			
	10 SPEEDS			
	400 V 3N ~ 50 Hz 70,2 kW	 450 H 710	8300x1110 2070/2200H 1150 kg	QX 680
	400 V 3N ~ 50 Hz 8,2 39 kg/h	5250/8100 dishes/h 6450* dishes/h	AS6 +600 mm	QX 680 AS6 QX 680 V QX 680 V AS6
	QX 780			
	10 SPEEDS			
	400 V 3N ~ 50 Hz 74,25 kW	 450 H 710	8600x1110 2070/2200H 1165 kg	QX 780
	400 V 3N ~ 50 Hz 9,25 kW 44 kg/h	5850/9000 dishes/h 6900* dishes/h	AS6 +600 mm	QX 780 AS6 QX 780 V QX 780 V AS6

- P** Prewash
- W** Wash
- 3R+** Reinforced triple rinse with low water consumption: double pre-rinse + rinse on module (reverse osmosis on request)
- AS6** Automatic shower with filter drawer +600 mm
- V** Steam-heated
- *** Productivity according to DIN SPEC 10534 (contact time)

EAC label upon request

Option compatibility to be confirmed by the manufacturer after verification

OPTIONS

				AUTOTIMER	PRE DOS	DDE-GROUP	DOS/S	SAN
Model	220-240 V 3 50 Hz	380-415 V 3N 50 Hz	60 Hz	Autotimer	DIHR disp. connections	Dispensers kit	Dispenser with probe	Sanitization
QX 250	+ 2%	●	+ 3%	●	●	€	€	€
QX 250 AS6	+ 2%	●	+ 3%	●	●	€	€	€
QX 250 V	+ 1%	●	+ 3%	●	●	€	€	€
QX 250 V AS6	+ 1%	●	+ 3%	●	●	€	€	€
QX 380	+ 2%	●	+ 3%	●	●	€	€	€
QX 380 AS6	+ 2%	●	+ 3%	●	●	€	€	€
QX 380 V	+ 1%	●	+ 3%	●	●	€	€	€
QX 380 V AS6	+ 1%	●	+ 3%	●	●	€	€	€
QX 420	+ 2%	●	+ 3%	●	●	€	€	€
QX 420 AS6	+ 2%	●	+ 3%	●	●	€	€	€
QX 420 V	+ 1%	●	+ 3%	●	●	€	€	€
QX 420 V AS6	+ 1%	●	+ 3%	●	●	€	€	€
QX 540	+ 2%	●	+ 3%	●	●	€	€	€
QX 540 AS6	+ 2%	●	+ 3%	●	●	€	€	€
QX 540 V	+ 1%	●	+ 3%	●	●	€	€	€
QX 540 V AS6	+ 1%	●	+ 3%	●	●	€	€	€
QX 600	+ 2%	●	+ 3%	●	●	€	€	€
QX 600 AS6	+ 2%	●	+ 3%	●	●	€	€	€
QX 600 V	+ 1%	●	+ 3%	●	●	€	€	€
QX 600 V AS6	+ 1%	●	+ 3%	●	●	€	€	€
QX 680	+ 2%	●	+ 3%	●	●	€	€	€
QX 680 AS6	+ 2%	●	+ 3%	●	●	€	€	€
QX 680 V	+ 1%	●	+ 3%	●	●	€	€	€
QX 680 V AS6	+ 1%	●	+ 3%	●	●	€	€	€
QX 780	+ 2%	●	+ 3%	●	●	€	€	€
QX 780 AS6	+ 2%	●	+ 3%	●	●	€	€	€
QX 780 V	+ 1%	●	+ 3%	●	●	€	€	€
QX 780 V AS6	+ 1%	●	+ 3%	●	●	€	€	€

● Standard

□ Upon request

DDE-GROUP Both detergent (with probe) and rinse-aid dispensers included

DWI Insulation option for the tunnel only, dryer excluded. Shelf dryer can be double skin upon request

Peak-cut connect upon request

Warm water supply 55 °C

We recommend to install the machine in a well-ventilated room, with a properly sized steam exhausting system.

	PAP-SAN	DWI	DWI / T	CONNECTIVITY	XP	PAP	DRIVE
Model	Booster pump sanitization	Thermoacoustic insulation	Tanks insulation	CONNECTIVITY (HACCP)	Extra power	Booster pump	Smart drive
QX 250	€	●	●	€	€	●	●
QX 250 AS6	€	●	●	€	€	●	●
QX 250 V	€	●	●	€	□	●	●
QX 250 V AS6	€	●	●	€	□	●	●
QX 380	€	●	●	€	€	●	●
QX 380 AS6	●	●	●	€	€	●	●
QX 380 V	€	●	●	€	□	●	●
QX 380 V AS6	●	●	●	€	□	●	●
QX 420	€	●	●	€	€	●	●
QX 420 AS6	●	●	●	€	€	●	●
QX 420 V	€	●	●	€	□	●	●
QX 420 V AS6	●	●	●	€	□	●	●
QX 540	●	●	●	€	€	●	●
QX 540 AS6	●	●	●	€	€	●	●
QX 540 V	●	●	●	€	€	●	●
QX 540 V AS6	●	●	●	€	€	●	●
QX 600	●	●	●	€	€	●	●
QX 600 AS6	●	●	●	€	€	●	●
QX 600 V	●	●	●	€	€	●	●
QX 600 V AS6	●	●	●	€	€	●	●
QX 680	●	●	●	€	€	●	●
QX 680 AS6	●	●	●	€	€	●	●
QX 680 V	●	●	●	€	€	●	●
QX 680 V AS6	●	●	●	€	€	●	●
QX 780	●	●	●	€	€	●	●
QX 780 AS6	●	●	●	€	€	●	●
QX 780 V	●	●	●	€	□	●	●
QX 780 V AS6	●	●	●	€	□	●	●

CONNECTIVITY Includes HACCP option. 10-year plan

XP In case of cold water supply for rinse (8-55 °C) and without any heat recovery, the extra power option is mandatory. In case of cold water supply for rinse (8-15 °C), we recommend the heat recovery option.

Option compatibility to be confirmed by the manufacturer after verification

OPTIONS

Model	10 speeds	Master switch	Surface filters	Peak-cut for Dühr dosing	Estimated consumption readout	PI	1-DRAIN
QX 250	●	●	●	●	●	€	●
QX 250 AS6	●	●	●	●	●	€	●
QX 250 V	●	●	●	●	●	€	●
QX 250 V AS6	●	●	●	●	●	€	●
QX 380	●	●	●	●	●	€	●
QX 380 AS6	●	●	●	●	●	€	●
QX 380 V	●	●	●	●	●	€	●
QX 380 V AS6	●	●	●	●	●	€	●
QX 420	●	●	●	●	●	€	●
QX 420 AS6	●	●	●	●	●	€	●
QX 420 V	●	●	●	●	●	€	●
QX 420 V AS6	●	●	●	●	●	€	●
QX 540	●	●	●	●	●	€	●
QX 540 AS6	●	●	●	●	●	€	●
QX 540 V	●	●	●	●	●	€	●
QX 540 V AS6	●	●	●	●	●	€	●
QX 600	●	●	●	●	●	€	●
QX 600 AS6	●	●	●	●	●	€	●
QX 600 V	●	●	●	●	●	€	●
QX 600 V AS6	●	●	●	●	●	€	●
QX 680	●	●	●	●	●	€	●
QX 680 AS6	●	●	●	●	●	€	●
QX 680 V	●	●	●	●	●	€	●
QX 680 V AS6	●	●	●	●	●	€	●
QX 780	●	●	●	●	●	€	●
QX 780 AS6	●	●	●	●	●	€	●
QX 780 V	●	●	●	●	●	€	●
QX 780 V AS6	●	●	●	●	●	€	●

● Standard

---- Not available

LANE Only with DRF69 and DRF6V

DIV Compulsory for machines > 4,5 m length

BT Booster pump included

DVGW Not available with heat recovery and steam condenser
Components prescribed by DVGW on request (check option compatibility with the manufacturer)

	AD	ECO-DET	X-BELT	LANE	DIV	BT	DVGW
Model	Automatic drain	Chemicals saving system	Special belt	Cutlery lane	Price per division	Break tank	DVGW
QX 250	●	●	+ 7 %	----	€	●	€
QX 250 AS6	●	●	+ 7 %	----	€	●	€
QX 250 V	●	●	+ 7 %	----	€	●	€
QX 250 V AS6	●	●	+ 7 %	----	€	●	€
QX 380	●	●	+ 7 %	----	€	●	€
QX 380 AS6	●	●	+ 7 %	----	€	●	€
QX 380 V	●	●	+ 7 %	----	€	●	€
QX 380 V AS6	●	●	+ 7 %	----	€	●	€
QX 420	●	●	+ 7 %	+ 5 %	€	●	€
QX 420 AS6	●	●	+ 7 %	----	€	●	€
QX 420 V	●	●	+ 7 %	+ 5 %	€	●	€
QX 420 V AS6	●	●	+ 7 %	----	€	●	€
QX 540	●	●	+ 7 %	----	€	●	€
QX 540 AS6	●	●	+ 7 %	----	€	●	€
QX 540 V	●	●	+ 7 %	----	€	●	€
QX 540 V AS6	●	●	+ 7 %	----	€	●	€
QX 600	●	●	+ 7 %	+ 5 %	€	●	€
QX 600 AS6	●	●	+ 7 %	----	€	●	€
QX 600 V	●	●	+ 7 %	+ 5 %	€	●	€
QX 600 V AS6	●	●	+ 7 %	----	€	●	€
QX 680	●	●	+ 7 %	----	€	●	€
QX 680 AS6	●	●	+ 7 %	----	€	●	€
QX 680 V	●	●	+ 7 %	----	€	●	€
QX 680 V AS6	●	●	+ 7 %	----	€	●	€
QX 780	●	●	+ 7 %	+ 5 %	€	●	€
QX 780 AS6	●	●	+ 7 %	----	€	●	€
QX 780 V	●	●	+ 7 %	+ 5 %	€	●	€
QX 780 V AS6	●	●	+ 7 %	----	€	●	€

Option compatibility to be confirmed by the manufacturer after verification

OPTIONS

Model	NZ3 Neutral zone 300	NZ6 Neutral zone 600	NZH6 Neutral zone for dryer 600	DRF68 Shelf dryer	DRF69 Shelf dryer	DRF6V Steam- heated shelf dryer	DRF70 Shelf dryer	DRF7V Steam- heated shelf dryer	DRF99M Stage dryer	DRF9VM Steam- heated stage dryer	DRF99MB Stage dryer with blowers	DRF9VMB Steam- heated stage dryer with blowers
QX 250 - QX 250 AS6	€	€	€	€	€	----	€	----	€	----	€	----
QX 250 V - QX 250 V AS6	€	€	€	€	€	€	€	€	€	€	€	€
QX 380 - QX 380 AS6	€	€	€	€	€	----	€	----	€	----	€	----
QX 380 V - QX 380 V AS6	€	€	€	€	€	€	€	€	€	€	€	€
QX 420 - QX 420 AS6	€	€	€	€	€	----	€	----	€	----	€	----
QX 420 V - QX 420 V AS6	€	€	€	€	€	€	€	€	€	€	€	€
QX 540 - QX 540 AS6	€	€	€	€	€	----	€	----	€	----	€	----
QX 540 V - QX 540 V AS6	€	€	€	€	€	€	€	€	€	€	€	€
QX 600 - QX 600 AS6	€	€	€	€	€	----	€	----	€	----	€	----
QX 600 V - QX 600 V AS6	€	€	€	€	€	€	€	€	€	€	€	€
QX 680 - QX 680 AS6	€	€	€	€	€	----	€	----	€	----	€	----
QX 680 V - QX 680 V AS6	€	€	€	€	€	€	€	€	€	€	€	€
QX 780 - QX 780 AS6	€	€	€	€	€	----	€	----	€	----	€	----
QX 780 V - QX 780 V AS6	€	€	€	€	€	€	€	€	€	€	€	€

--- Not available

NZ3 Recommended with big quantities of trays to wash

NZ6 Recommended with big quantities of trays to wash. Module equipped with a front door

NZH6 Recommended with dryers with blowers

DRF99M - DRF9VM - DRF99MB Module with front door

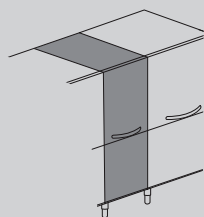

NZ3 + 300 mm
Neutral zone

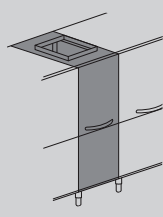

NZH6 + 600 mm
Neutral zone with door
for dryer

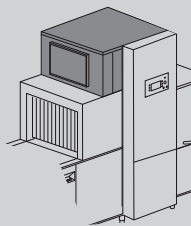

DRF68 9 kW
Shelf drying compact

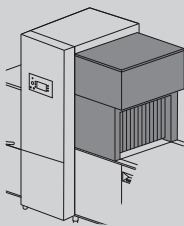

DRF69 9 kW
Shelf dryer

DRF6V
Steam-heated shelf dryer

DRF70
Double skin lateral shelf
dryer with upper fan

DRF7V
Steam-heated double
skin shelf lateral dryer
with upper fan

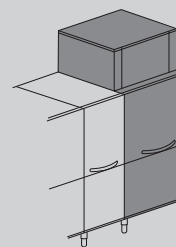

DRF99M
+ 900 mm - 9 kW
Dryer module

DRF9VM + 900 mm
Steam-heated dryer
module

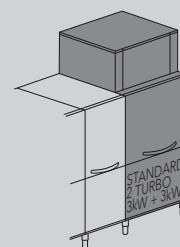

DRF99MB
+ 900 mm - 15 kW
Dryer module

DRF9VMB + 900 mm
Steam-heated dryer
module

Model	SCF10 Steam condenser	SCF15 Steam condenser	HRF15 Heat recovery	HRF20 Heat recovery	HRPF40 Heat recovery	3R+ Triple reinforced rinse	3R+ RO Triple reinforced rinse with RO	STOCK Chemicals compartment	HDRF Heat recovery with dryer	HDRFV Heat recovery with dryer
QX 250 - QX 250 AS6	€	€	€	€	€	●	€	€	€	----
QX 250 V - QX 250 V AS6	€	€	€	€	€	●	€	€	----	€
QX 380 - QX 380 AS6	€	€	€	€	€	●	€	€	€	----
QX 380 V - QX 380 V AS6	€	€	€	€	€	●	€	€	----	€
QX 420 - QX 420 AS6	€	€	€	€	€	●	€	€	€	----
QX 420 V - QX 420 V AS6	€	€	€	€	€	●	€	€	----	€
QX 540 - QX 540 AS6	€	€	€	€	€	●	€	€	€	----
QX 540 V - QX 540 V AS6	€	€	€	€	€	●	€	€	----	€
QX 600 - QX 600 AS6	€	€	€	€	€	●	€	€	€	----
QX 600 V - QX 600 V AS6	€	€	€	€	€	●	€	€	----	€
QX 680 - QX 680 AS6	€	€	€	€	€	●	€	€	€	----
QX 680 V - QX 680 V AS6	€	€	€	€	€	●	€	€	----	€
QX 780 - QX 780 AS6	€	€	€	€	€	●	€	€	€	----
QX 780 V - QX 780 V AS6	€	€	€	€	€	●	€	€	----	€

SCF15 Not available with dryer

3R+ Reinforced triple rinse: Improved consumptions (Reverse osmosis on request).
With osmotic water supply and electrical conductivity lower than 200 microsiemens, it is mandatory to install a stainless steel heat exchanger

HRF15 - HRF20 - HRPF40 - HDRF - HDRFV In case of cold water supply for rinse (8-15 °C), we recommend to install the heat recovery system optional

All dryers are double skin. Option compatibility to be confirmed by the manufacturer after verification

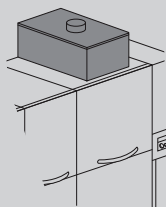

SCF10
Steam condenser

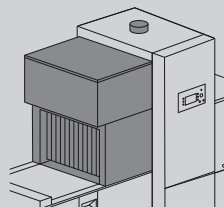

HRF15
Reinforced compact
heat recovery

SCF15
Reinforced steam condenser

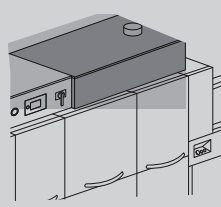

HRF20
Heat recovery

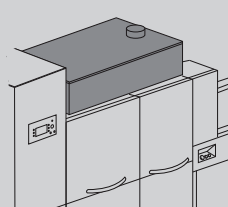

HRPF40
Heat recovery with heat
pump

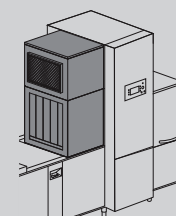

HDRF
Electric dryer 9 kW + heat
recovery

HDRFV
Steam heated dryer + heat
recovery

OPTIONS

	MI900	MI1200	MIS1200	MI1500	MI1800	MI2200	MIR2200
Model	Entry mod. 900	Entry mod. 1200	Over. entry mod. 1200	Entry mod. 1500	Entry mod. 1800	Entry mod. 2200	Lowered belt entry mod. 2200
QX 250 - QX 250 AS6	€	€	●	€	€	€	
QX 250 V - QX 250 V AS6	€	€	●	€	€	€	
QX 380 - QX 380 AS6	€	€	●	€	€	€	
QX 380 V - QX 380 V AS6	€	€	●	€	€	€	
QX 420 - QX 420 AS6	€	€	●	€	€	€	
QX 420 V - QX 420 V AS6	€	€	●	€	€	€	
QX 540 - QX 540 AS6	€	€	●	€	€	€	
QX 540 V - QX 540 V AS6	€	€	●	€	€	€	
QX 600 - QX 600 AS6	€	€	●	€	€	€	
QX 600 V - QX 600 V AS6	€	€	●	€	€	€	
QX 680 - QX 680 AS6	€	€	●	€	€	€	
QX 680 V - QX 680 V AS6	€	€	●	€	€	€	
QX 780 - QX 780 AS6	€	€	●	€	€	€	
QX 780 V - QX 780 V AS6	€	€	●	€	€	€	

- Standard
- Upon request
- Not available

Option compatibility to be confirmed by the manufacturer after verification

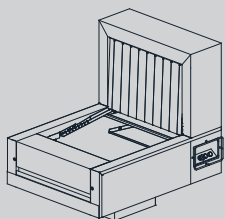

Overhanging entry module

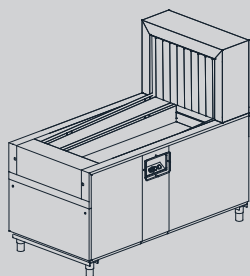

Entry module

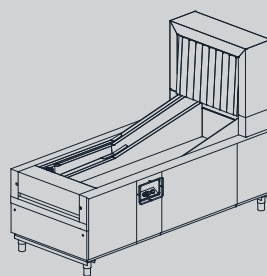

Lowered belt entry module

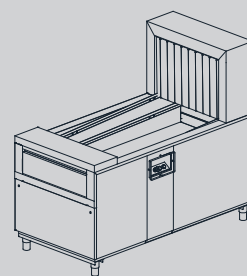

Exit module

	MI2700	MIR2700	EM900	EM1200	EM1500	EM1800	EM2200	EM2700
Model	Entry mod. 2700	Lowered belt entry mod. 2700	Exit mod. 900	Exit mod. 1200	Exit mod. 1500	Exit mod. 1800	Exit mod. 2200	Exit mod. 2700
QX 250 - QX 250 AS6	€	€	□	□	□	●	€	€
QX 250 V - QX 250 V AS6	€	€	□	□	□	●	€	€
QX 380 - QX 380 AS6	€	€	□	□	□	●	€	€
QX 380 V - QX 380 V AS6	€	€	□	□	□	●	€	€
QX 420 - QX 420 AS6	€	€	□	□	□	●	€	€
QX 420 V - QX 420 V AS6	€	€	□	□	□	●	€	€
QX 540 - QX 540 AS6	€	€	□	□	□	●	€	€
QX 540 V - QX 540 V AS6	€	€	□	□	□	●	€	€
QX 600 - QX 600 AS6	€	€	□	□	□	●	€	€
QX 600 V - QX 600 V AS6	€	€	□	□	□	●	€	€
QX 680 - QX 680 AS6	€	€	□	□	□	□	●	€
QX 680 V - QX 680 V AS6	€	€	□	□	□	□	●	€
QX 780 - QX 780 AS6	€	€	□	□	□	□	●	€
QX 780 V - QX 780 V AS6	€	€	□	□	□	□	●	€

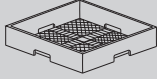
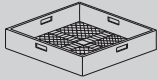
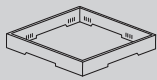
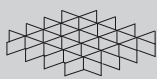
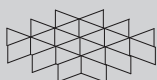
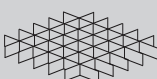
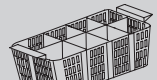
	Description	Capacity	Dimensions	Code	
	NARROW MESH CUTLERY BASKET		500x500x106 H	C 41	
	LARGE MESH BASKET	For glasses	500x500x105 H	C 44	
	HOLDER FOR GLASS SUPPORT	For glass support (C112-C113-C114)	500x500x50 H	C 111	
	GLASS SUPPORT	5x5 Glass Ø 87 mm (C 111)	500x500x50 H	C 112	
	GLASS SUPPORT	4x4 Glass Ø 110 mm (C 111)	500x500x50 H	C 113	
	GLASS SUPPORT	6x6 Glass Ø 72 mm (C 111)	500x500x50 H	C 114	
	CUTLERY BASKET		490x180x140 H	C 47	



The standard heat recovery uses the steam produced by the machine to preheat the incoming cold water for immediate energy savings. The special twin-cord conveyor system, sloped and separated by zone, avoids any contamination

among modules and supports the special cold dryer at high pressure. Thanks to its turbo blowers with custom-made air-blades, this technology allows the immediate re-use of the trays.



SELF-CLEANING

The machine's cleaning and sanitization is one of the most dreaded tasks to accomplish at the end of a day at work in the kitchen. For this reason, we have conceived a sanitization system which ensures a thorough and immediate cleaning of all machine's surfaces thanks to the special rinse arms installed on the upper wall, thus offering the perfect solution to meet maximum hygiene requirements. A dedicated sanitization product is combined with a booster pump ensuring the right water pressure: the result will be a spick and span dishwasher!

FEATURES

- Low voltage electronic control panel
- Fast coupling wash-arms, with concave self cleaning nozzles, equipped with flow adjuster
- ACID PROOF AISI 316 wash tanks, with rounded corners to guarantee a perfect hygiene
- The overflow pipe enables the full draining of the wash tanks without removal
- ACID PROOF AISI 316 stainless steel boilers, fully insulated to reduce thermal losses
- Standard heat recovery
- Double skin insulated doors, counter-balanced, equipped with anti-drop safety system
- THERMO BARRIER system for comfort in use
- CLEAN+ filters
- Built-in turbo blowers feed the air nozzles positioned both above and below the twin-cords
- Turbo-blowers. Thanks to a high pressure of the air vortex
- Trays accumulator in the absence of trolley
- Advancement system. Eases the removal of any solid residual on the tray allowing its complete rinse
- Two speeds traction system with built-in clutch. Speed adjuster on request
- Non-return valve
- Autotimer: built-in device that switches the electrical options
- HACCP: data management software on request

Model	Voltage	Capacity	Dimensions	Code
TX 1600	400 V 3N ~ 50 Hz 44 kW 8,4 - 13,1 m/min Cold water supply	GN 1/1 530x325x35 H	2575x805 2040/2120 H 485 kg	TX 1600

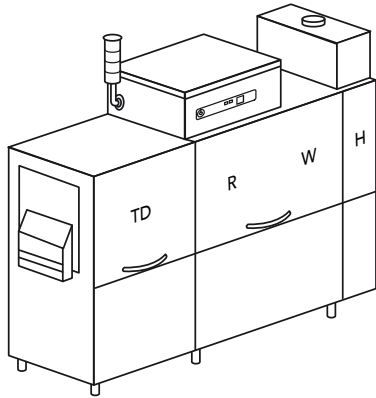

- W** Wash
- R** Rinse
- TD** Cold dryer with turbo blowers
- H** Heat recovery

OPTIONS

	DDE-GROUP	DOS/S	PAP	DRIVE
Model	220-240 V 3 50 Hz	380-415 V 3N 50 Hz	60 Hz	Trays Accumulator
	Dispensers Kit	Dispenser with Probe	Booster Pump	Smart drive
TX 1600	€	•	+3%	•

- Standard
- DDE-GROUP** Both detergent (with probe) and rinse aid dispensers included
- DOS/S** Only for detergent dispenser
- DRIVE** Check voltage compatibility

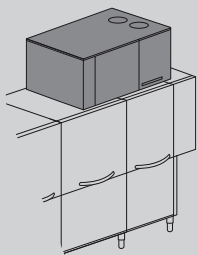

HRP40
Heat recovery with heat pump

Model	Capacity	Dimensions	Code
PF TROLLEY FOR TRAYS	 530x325x35 H	800x500x900 H 30 kg	PF

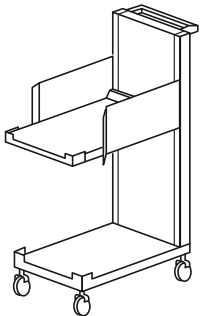

	DWI	HACCP	PI	AUTOTIMER	HR5	HRP40	SAN	PAP-SAN	BT
Model	Thermoacoustic insulation	HACCP supervisor	S/S Pumps	Autotimer	Heat recovery	Heat recovery with heat pump	Sanitization	Booster Pump Sanitization	Break Tank
TX 1600	€	€	€	●	●	€	€	€	€

- HR5** Heat recovery (cold water supply 8-15 °C)
- DWI** Insulation option for the tunnel only, dryer excluded. Recommended with the standard heat recovery HR5 and with the HRP40
- HACCP** Software and cables included
- HRP40** In alternative to standard compact heat recovery
- BT** Booster pump included

Division not available

Option compatibility to be confirmed by the manufacturer after verification







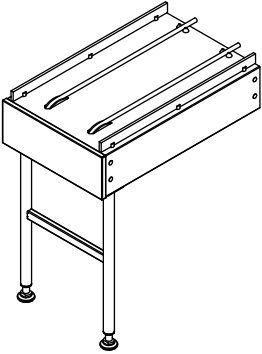

We recommend to install the machine in a well ventilated room, with a properly sized steam exhausting system

EAC label upon request

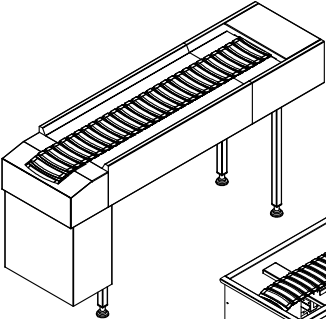

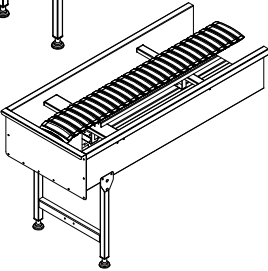
Our customized bi-cord transport system is the perfect solution not only to carry, but also to wash and deliver trays. The system limits the workers operations and contains management costs and space while perfectly drying the trays for an immediate use.

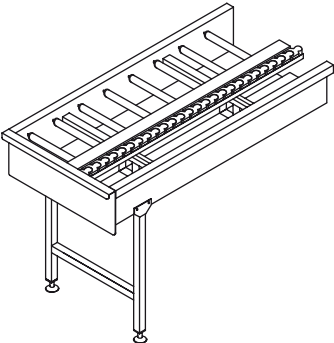
With the recent expansion of the range, DIHR now offers tailor-made logistics and waste treatment solutions. Thanks to this comprehensive offer, even the most specific customer needs can be satisfied.

Model	Voltage	Capacity	Code	€
CORD CONVEYOR				
	400 V 3N 50 Hz -- 230 V 50 Hz -- 230 V 3 50 Hz Special voltages on request	 530x325x35 H	BCC	upon request
SLAT CONVEYOR FOR TRAYS OR RACKS				
	400 V 3N 50 Hz -- 230 V 50 Hz -- 230 V 3 50 Hz Special voltages on request	 530x325x35 H	SCT trays	upon request
		 500x500	SCR racks	upon request
CARDAN CHAIN CONVEYOR				
	400 V 3N 50 Hz -- 230 V 50 Hz -- 230 V 3 50 Hz Special voltages on request	 500x500	CCC	upon request



The technology of the LP line will lead you in an easy and intuitive way, through the functions of your pot washer, directly from the control panel. The TFT color display (LP1 S8 PLUS / LP2 S PLUS / LP3 S PLUS / LP4 S8 PLUS) eases the visualization of the working temperatures and the set wash cycles, both easily modifiable. With the new motorized valve implemented on the LP2 S PLUS, LP3 S PLUS and LP4 S8 PLUS, together with the possibility of sche-

during the start of the cycle, we greatly facilitated the use and maintenance of these models. The two-level self-diagnosis system, also present on the LP1 S8 PLUS, allows you to any anomaly very accurately. Besides, the optimized Optimal Rinse rinsing system, the additional Energy Saving function, the high-level performance and high quality of our materials, the competitiveness and versatility of our LP range reach levels that are hard to find on the market.



FEATURES LP1 S4 - LP1 S5 PLUS

- Four wash cycles (customizable for LP1 S4)
- Soft Start wash pump (LP1 S4)
- New intuitive electronic control panel (LP1 S4)
- High capacity in small dimensions
- Versatility of use
- Double skin
- Deep-formed tank
- Triple pump filter (LP1 S4)
- Trays (600x400 mm with 90° angle) and EURONORM crates 600x400x400H (with specific griddle 575010)
- Automatic self-cleaning cycle
- PLUS system for a constant rinse (LP1 S5 PLUS)
- Built-in water softener available with automatic regeneration cycle (LP1 S4)
- CONNECTIVITY remote control compliant with the HACCP norms (on request for LP1 S4)

FEATURES LP1 400 PLUS

- Easy and intuitive LED electronic control panel
- Modification of the dosage of detergent and rinse-aid directly on the on the control panel
- Remote control panel available on request instead of the standard control panel
- Four customizable programs
- Single skin hood
- Double tank filters, with dirt collection system and pump filter (improved system for a better filtration of the wash water)
- Self-cleaning vertical pump
- Soft Start wash pump
- Easy to access for maintenance
- Anti-drop roof panel
- Easily removable basket support
- Self-cleaning cycle
- The Plus system grants a constant rinse temperature and pressure thanks to the rinse pump
- CONNECTIVITY remote control compliant with the HACCP norms (on request)





FEATURES LP1 800

- LED control panel with four programmable cycles
- Max loading 805 mm
- Double skin door
- Deep-formed tank
- Double tank filter + pump filter
- Standard rinse pump
- Anti-drop roof panel
- Self-cleaning automatic cycle
- Basket 550x665 mm
- Stainless steel wash and rinse arms



NEW ELECTRONIC CONTROL PANEL

- LED electronic control panel
- Intuitive START button with multi-color backlight for quick viewing of machine status
- Display of wash and rinse temperatures, cycle progress, selected cycle, machine status (stand-by, end of cycle, etc.) and main warnings description (door opening, drainage, etc.)
- Language selection not available
- 4 programmable cycles (2 - 4 - 6 - 8 minutes)
- Possibility to install the Connectivity-Cloud option

With the warewashing models LP1 S8 HR / LP2 S HR / LP3 S HR / LP4 S8 HR PLUS, DIHR offers significant energy savings. The HR system is a heat exchanger: the moist warm water vapour is directly drawn out of the machine when the door is closed, and used for pre-heating the cold water inlet up to around 50 °C. As a result, the energy required to reach the final rinse temperature (approximately 85 °C) is dramatically reduced. Depending on the model, you can save between

3,5 kWh and 5,5 kWh. DIHR HR technology improves the room air quality and climate as well. The heat exchanger reduces the exhaust air temperature by more than half. The entire humidity volume is cut down by approximately 20% of the equivalent machine without any heat recovery unit. This permanently improves the operators' comfort.



FEATURES LP1 S8 PLUS - LP2 S PLUS - LP3 S PLUS - LP4 S8 PLUS

- Electronic with energy saving system
- Double skin
- Standard rinse pump
- Self cleaning vertical pump
- Deep-formed chair tank
- Stainless steel independent wash/rinse arms
- Double tank filter with dirt collection system
- Thermostat to grant the rinse temperature according to HACCP regulations
- Multichromatic START key
- Automatic self-cleaning cycle
- Four customizable wash cycles
- The wash pump activate one after the other to reduce the electric peak (LP2 S / LP3 S / LP4 S8 PLUS)
- Double skin door that can be used as a countertop
- Innovative drain valve system (LP2 S / LP3 S / LP4 S8 PLUS) for automatized drain
- 5" TFT touch display
- Optional heat recovery (HR)
- CONNECTIVITY remote control compliant with the HACCP norms (on request)

CONNECTIVITY 4.0 & APP

WHEREVER YOU ARE...
YOUR DISHWASHER, JUST A CLICK AWAY

You will be constantly connected to the machine to monitor the work phases, review any eventual alarm and configure remotely the operating parameters according to your needs. Compliant with HACCP norms. Thanks to our brand new App, you will have access to connected machines and all commercial and technical documentation.

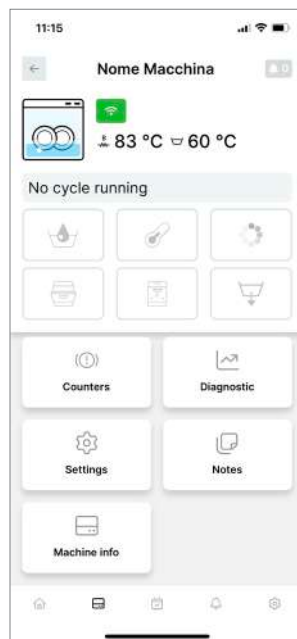

View all the working parameters and historical events, working hours and any problems at any time.



In case of problems, the machine promptly sends an email to you and to the technician who can intervene remotely to solve the problem or equip himself for on-site intervention.



The program allows you to remove an Excel file with all Haccp data at any time.



Our Connectivity system is a revolutionary device limiting and facilitating the eventual intervention of a technician who can anticipate the necessary parts to be replaced, saving time and money.

 STEAM
RECOVERY

 ENERGY
SAVINGS

SUSTAINABILITY



HR:

HEAT RECOVERY SYSTEM

With the DIHR warewashing models LP1 S8 HR / LP2 S HR / LP3 S HR / LP4 S 8HR Plus, up to 50% of energy costs can be saved!

The HR system is a heat exchanger: the moist warm water vapour is drawn directly out of the machine when the door is closed, and used for pre-heating the cold water supplied up to around 50°C. As a result, the energy required to reach the final rinse temperature (approx. 85°C) is dramatically reduced.









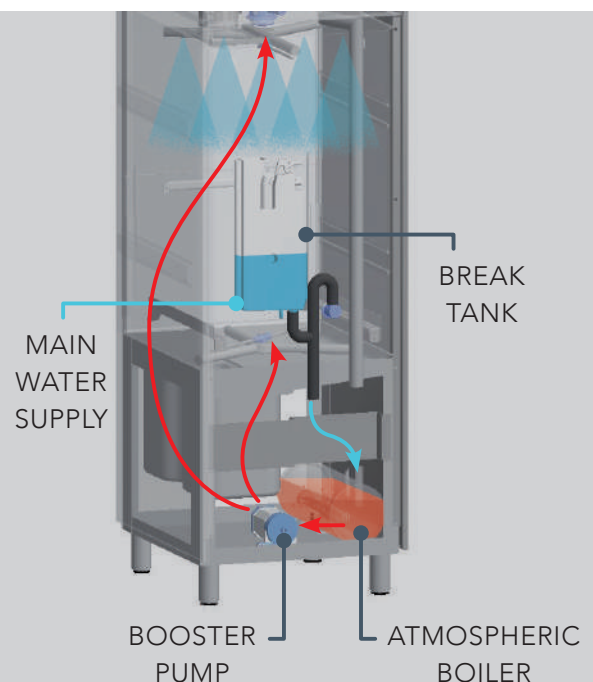

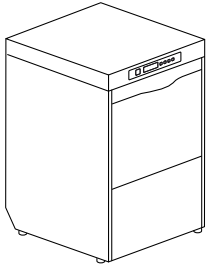





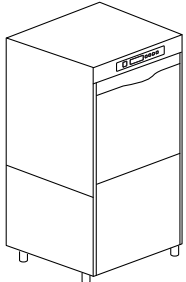

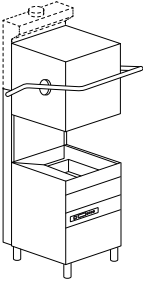

Depending on the model you can save between 3,5kWh and 5,5kWh. DIHR HR technology improves the room's air quality and climate as well. The heat exchanger reduces the exhaust air temperature by more than an half.



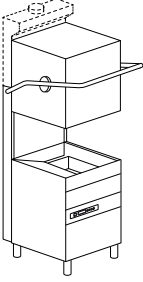



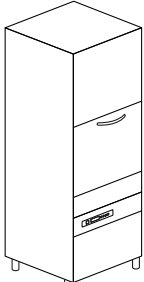

The entire humidity volume is cut down by approx.-20% of the equivalent machine without a heat recovery unit. This permanently improves the operators' comfort.

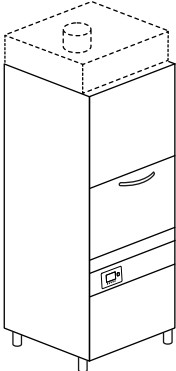
PLUS SYSTEM

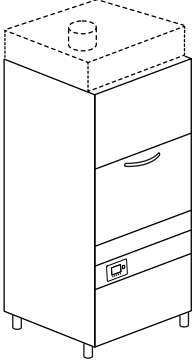
The rinse cycle is stabilized at 85°C temperature and flows at a constant pressure, thanks to the atmospheric boiler which avoids to add fresh water from the mains, when rinsing. Moreover the PLUS System grants a better control and a correct dosage of rinse-aid at every cycle.

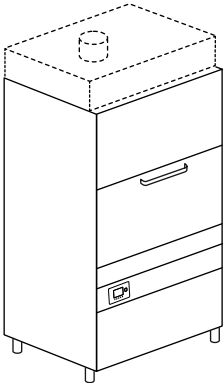

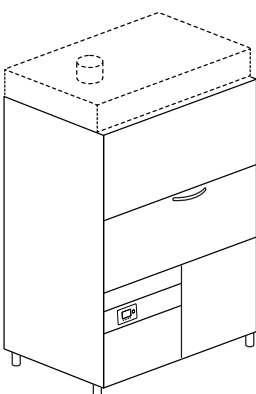
Model		Voltage	Capacity	Dimensions	Code
LP1 S4	4 PROGRAMS				
	<p>RACK EQUIPMENT</p> <ul style="list-style-type: none"> 1 X 575005 1 X C44 1 X C86/A 1 X 575010 	<p>Multivoltage:</p> <p>Standard 400 V 3N 50 Hz 6,7 kW</p> <p>or 230 V 3 50 Hz 6,7 kW</p> <p>or 230 V 50 Hz 6,7 kW</p>	<p> 400 H</p> <p> Ø 400</p> <p> 500x500</p>	<p>600x680x850 H 68 kg</p> <p> 600x400x25 H</p> <p> 600x400x400 H</p>	<p>LP1 S4</p> <p>LP1 S4 DA</p> <p>surface filters</p>
LP1 S5 PLUS	4 PROGRAMS				
	<p>RACK EQUIPMENT</p> <ul style="list-style-type: none"> 1 X 575005 1 X 575010 1 X C132 1 X C86/A 	<p>400 V 3N ~ 50 Hz 10,2 kW</p>	<p> 440 H</p> <p> 500x500</p> <p> 500x610</p>	<p>600x700x1380 H 100 kg</p> <p> 600x400x25 H</p>	<p>LP1 S5 PLUS</p>
LP1 400 PLUS	4 PROGRAMS - HR: HEAT RECOVERY				
	<p>RACK EQUIPMENT</p> <ul style="list-style-type: none"> 1 X 11600054 1 X C44 1 X C86/A 	<p>400 V 3N ~ 50 Hz 10,49 kW</p>	<p> Ø 410</p> <p> 500x600</p>	<p>720x735x1445/1915 H 104 kg</p> <p>HR: 720x735x2095 H</p> <p> 600x400x25 H (HT tables)</p>	<p>LP1 400 PLUS</p> <p>LP1 400 PLUS DA</p> <p>LP1 400 PLUS HR</p> <p>LP1 400 PLUS HR DA</p>
LP1 400 PLUS LIFT	4 PROGRAMS - HR: HEAT RECOVERY				
	<p>RACK EQUIPMENT</p> <ul style="list-style-type: none"> 1 X 11600054 1 X C44 1 X C86/A 	<p>400 V 3N ~ 50 Hz 10,49 kW</p>	<p> Ø 410</p> <p> 500x600</p>	<p>720x735x1445/1915 H 104 kg</p> <p>HR: 720x735x2095 H</p> <p> 600x400x25 H (HT tables)</p>	<p>LP1 400 PLUS LIFT</p> <p>LP1 400 PLUS LIFT DA</p> <p>LP1 400 PLUS HR LIFT</p> <p>LP1 400 PLUS HR LIFT DA</p>
LP1 800	4 PROGRAMS				
	<p>RACK EQUIPMENT</p> <ul style="list-style-type: none"> 1 X C86/A 1 X C87/B 1 X C97/A 1 X C100 	<p>400 V 3N ~ 50 Hz 8,2 kW</p>	<p> 805 H</p> <p> 550x665</p>	<p>650x750x1690/2070 H 110 kg</p>	<p>LP1 800</p>

Model		Voltage	Capacity	Dimensions	Code
LP1 S8 PLUS	4 PROGRAMS - HR: HEAT RECOVERY				
	<p>RACK EQUIPMENT</p> <ul style="list-style-type: none"> 1 X C86/A 1 X C87/B 1 X C97/A 1 X C100 	400 V 3N ~ 50 Hz 8,2 kW	 805 H  550x665	690x800x1890/2275 H 155 kg 690x800x2165/2275 H 165 kg	LP1 S8 PLUS LP1 S8 HR PLUS
LP2 S PLUS	4 PROGRAMS - HR: HEAT RECOVERY				
	<p>RACK EQUIPMENT</p> <ul style="list-style-type: none"> 1 X 91100 1 X C86/A 1 X C97/A 	400 V 3N ~ 50 Hz 12,5 kW	 645 H  700x700	840x885x1790/2050 H 199 kg 840x885x2140 H 215 kg	LP2 S PLUS LP2 S HR PLUS
LP3 S PLUS	4 PROGRAMS - HR: HEAT RECOVERY				
	<p>RACK EQUIPMENT</p> <ul style="list-style-type: none"> 1 X 92100 1 X C86/A 1 X C97/A 	400 V 3N ~ 50 Hz 13,4 kW	 645 H  850x725	990x885x1790/2050 H 221 kg 990x885x2140 H 237 kg	LP3 S PLUS LP3 S HR PLUS
LP4 S8 PLUS	4 PROGRAMS - HR: HEAT RECOVERY				
	<p>RACK EQUIPMENT</p> <ul style="list-style-type: none"> 1 X 93600 1 X C86/A 1 X C97/A 	400 V 3N ~ 50 Hz 14,8 kW 400 V 3N ~ 50 Hz 5,8 kW 25 kg/h	 820 H  1350x725	1490x885x1970/2310 H 320 kg 1490x885x2320 H 343 kg 1490x885x1970/2310 H 320 kg 1490x885x2320 H 343 kg	LP4 S8 PLUS LP4 S8 HR PLUS LP4 S8 V LP4 S8 V HR

OPTIONS

Model	220-240 V 50 Hz		380-415 V 3N 50 Hz		220-240V 3 50 Hz		380-415 V 3 50 Hz		60 Hz	440 V 3 60 Hz	XP	PS	SA	CONTROL
	M	●	□	€	€	€	€	Extra Power			Drain Pump	Automatized drain	Substitute remote control panel	
LP1 S4	M	●	M	----	€	----	----	€	€	€	€	€	----	----
LP1 S4 DA	M	●	M	----	€	----	----	€	€	€	€	€	----	----
LP1 S5 PLUS	€	●	□	----	€	----	----	€	€	€	€	€	----	----
LP1 400 PLUS*	----	●	□	€	€	€	€	€	€	€	€	€	----	€
LP1 400 PLUS DA*	----	●	□	€	€	€	€	€	€	€	€	€	----	€
LP1 400 PLUS HR*	----	●	□	€	€	€	€	€	€	€	€	€	----	€
LP1 400 PLUS HR DA*	----	●	□	€	€	€	€	€	€	€	€	€	----	€
LP1 400 PLUS LIFT*	----	●	□	€	€	€	€	€	€	€	€	€	----	€
LP1 400 PLUS LIFT DA*	----	●	□	€	€	€	€	€	€	€	€	€	----	€
LP1 400 PLUS HR LIFT*	----	●	□	€	€	€	€	€	€	€	€	€	----	€
LP1 400 PLUS HR LIFT DA*	----	●	□	€	€	€	€	€	€	€	€	€	----	€
LP1 800*	----	●	□	€	€	----	€	€	€	€	€	€	----	----
LP1 S8 PLUS	----	●	□	€	€	----	€	€	€	€	€	€	----	----
LP1 S8 HR PLUS	----	●	□	€	€	----	€	€	€	€	€	€	----	----
LP2 S PLUS	----	●	□	€	€	----	€	€	€	€	€	€	●	----
LP2 S HR PLUS	----	●	□	€	€	----	€	€	€	€	€	€	●	----
LP3 S PLUS	----	●	□	€	€	----	€	€	€	€	€	€	●	----
LP3 S HR PLUS	----	●	□	€	€	----	€	€	€	€	€	€	●	----
LP4 S8 PLUS	----	●	□	€	€	----	€	€	€	€	€	€	●	----
LP4 S8 HR PLUS	----	●	□	€	€	----	€	€	€	€	€	€	●	----
LP4 S8 V	----	●	□	€	€	----	€	€	€	€	€	€	●	----
LP4 S8 V HR	----	●	□	€	€	----	€	€	€	€	€	€	●	----

- Standard
- Upon request
- Not available
- M** Multivoltage
- DA** Built-in automatic water softener
- V** Steam heated
- *** All models are equipped with double skin, except LP1 400 PLUS and LP1 800
- PLUS** Rinse with constant temperature and stabilized consumption
- LIFT** Automatic hood lift at the end of the cycle

Water supply 55 °C (except HR versions)

EAC label upon request

Option compatibility to be confirmed by the manufacturer after verification

HACCP Software and cabled included

220-240 V 50 HZ For LP1 S5 Plus max boiler heating element 6000 W

Model	DDE Deter- gent Dispen- ser	DB Rinse-Aid Dispenser	DBE Peristaltic Rinse-Aid Disp.	HACCP HACCP Supervisor	CONNECTIVITY CONNECTIVITY (HACCP)	BT Break Tank	WRAS Wras	DVGW DVGW	PAP Booster Pump	PI S/S Pumps	FLOAT Probes Lack Det and rinse aid
LP1 S4	€	●	€	----	€	€	€	€	€	----	€
LP1 S4 DA	€	●	€	----	€	----	€	€	€	----	€
LP1 S5 PLUS	€	----	●	€	----	●	€	€	●	----	€
LP1 400 PLUS*	€	----	●	----	€	●	€	€	●	----	€
LP1 400 PLUS DA*	€	----	●	----	€	----	----	----	●	----	€
LP1 400 PLUS HR*	€	----	●	----	€	●	----	----	●	----	€
LP1 400 PLUS HR DA*	€	----	●	----	€	----	----	----	●	----	€
LP1 400 PLUS LIFT*	€	----	●	----	€	●	€	€	●	----	€
LP1 400 PLUS LIFT DA*	€	----	●	----	€	----	----	----	●	----	€
LP1 400 PLUS HR LIFT*	€	----	●	----	€	●	----	----	●	----	€
LP1 400 PLUS HR LIFT DA*	€	----	●	----	€	----	----	----	●	----	€
LP1 800*	€	●	€	----	€	----	----	----	●	----	€
LP1 S8 PLUS	€	----	●	----	€	●	€	€	●	----	€
LP1 S8 HR PLUS	€	----	●	----	€	●	----	----	●	----	€
LP2 S PLUS	€	----	●	----	€	●	€	€	●	€	€
LP2 S HR PLUS	€	----	●	----	€	●	----	----	●	€	€
LP3 S PLUS	€	----	●	----	€	●	€	€	●	€	€
LP3 S HR PLUS	€	----	●	----	€	●	----	----	●	€	€
LP4 S8 PLUS	€	----	●	----	€	●	€	€	●	----	€
LP4 S8 HR PLUS	€	----	●	----	€	●	----	----	●	----	€
LP4 S8 V	€	----	●	----	€	----	----	----	●	----	€
LP4 S8 V HR	€	----	●	----	€	----	----	----	●	----	€

PS Not available with 380-415 V 3 50 Hz and 440 V 3 60 Hz

PI Available with 50 Hz frequency only

XP In case of cold water supply for rinse (8-55 °C) and without any heat recovery , the extra power option is mandatory. +3000 W with standard voltage only, for other voltages please contact us. In case of cold water supply for rinse (8-15 °C), we recommend the heat recovery option

WRAS - DVGW Booster pump included. LP1 S4 S machine depth + 20 mm

DVGW Components prescribed by DVGW on request (check option compatibility with the manufacturer)



CONNECTIVITY Includes HACCP option. 10-year plan

HR Heat recovery (in case of cold water supply 8-15 °C)

The ENERGY RECOVERY SYSTEM uses the heat produced by the machine to preheat the infeed of cold rinse water supply 8-15 °C

Optimal air temperature in the dishwashing area thanks to the reduction of the steam and the humidity produced by the machine

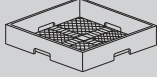
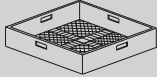
HR available in case of osmotic water supply if the electrical conductivity is higher than 200 microsiemens

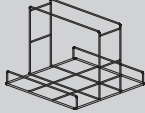
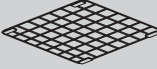
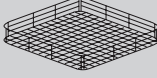
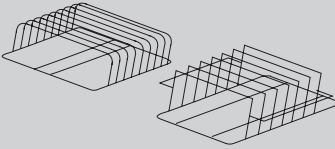
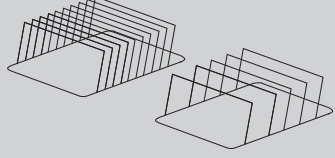
	Description	Capacity	Dimensions	Code
	NARROW MESH CUTLERY BASKET	For glasses	500x500x106 H	C 41
	LARGE MESH BASKET	For glasses	500x500x105 H	C 44
	REUSABLE CUP BASKET	5x5 glasses 30 mm <math>\lt; \varnothing < 90 \text{ mm}</math> H max 185 mm LP1 S4 LP1 S5 PLUS	500x500x235 H	C 135 
	GRIDDLES Basket holder 2 pcs max. depth 80 mm	LP1 S4 LP1 S5 PLUS	500x500x380 H	575005/P
	GRIDDLES	LP1 S4 LP1 S5 PLUS	500x500	575010
		LP1 800 LP1 S8 PLUS	550x550	C 100
	STAINLESS STEEL BASKETS	LP1 S5 PLUS	500x610x75 H	C 132
		LP1 800 - LP1 S8 PLUS	550x665x75 H	C 87/B
		LP2 S PLUS	700x700x130 H	91100
		LP3 S PLUS	850x725x130 H	92100
		LP4 S8 PLUS	1350x725x130 H	93600
	TRAY SUPPORTS 6 pcs max. depth 25 mm	LP1 S4 LP1 S5 PLUS	500x500x160 H	575005
		LP1 400 PLUS	500x605x160 H	11600054
	TRAY SUPPORTS 8 pcs max. depth 25 mm	LP1 800 LP1 S8 PLUS LP2 S PLUS LP3 S PLUS LP4 S8 PLUS	300x465x210 H	C 97/A
	TRAY SUPPORTS 4 pcs max. depth 65 mm			C 97/B

	Description	Capacity	Dimensions	Code	
	SPATULA BASKET		150x150x250 H	C 86/A	
			220x220x420 H	C 85/A	
	WATER SOFTENER	12 l	Ø 200x500 H	D 1	
	AUTOMATIC WATER SOFTENER	12 l (max 800 l)	315x510x685 H	D 2	
	STAINLESS STEEL STAND	LP1 S4	592x535x500 H	999900517	



Why waste your time with soak and prewash when there are plenty of more useful things to be done in the kitchen? Consider giving a value to wasted hours and the amount of water and detergent used to moisten encrusted pans. Plus the time and effort to scrub, wash and dry them! The conclusion is easily deduced; it's a waste of time, energy and resources. A waste of money. This is when the DIHR Granules Utensil Washers enter

the scene. The abrasive power of the projected granules, mixed together with water and detergent, guarantee an excellent result in a few minutes wash. Even with the most tenaciously encrusted pans. A precious and necessary equipment designed to fulfil the needs of canteens, caterers, airports and restaurants' modern kitchens, giving the right value to time and money.

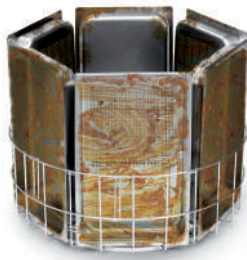

 Encrusted pots and pans are often a problem. They require soaking and manual cleaning therefore a waste of time and resources only for this particular task.



 The combined action of water, detergent and granules blasted at high pressure ensures considerable time and energy savings, as well as chemicals, water and electricity. All in favour of our environment.

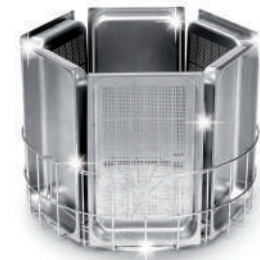

 Excellent results against the most stubborn dirt. Moreover, the speedy cycles allow a quick re-use of the kitchenware. The Staff that was previously employed to soak and hand wash, will now be free to perform other tasks.

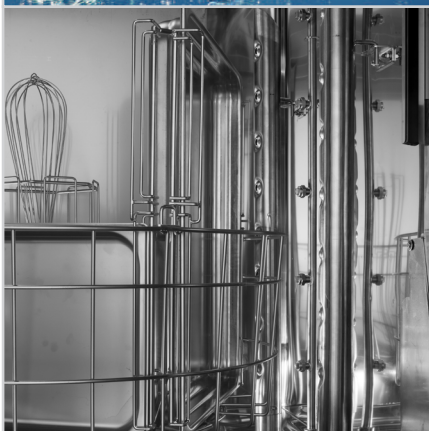
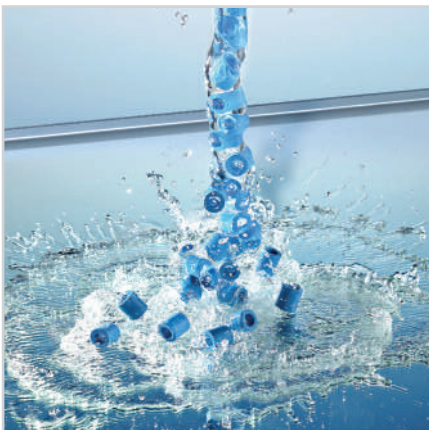







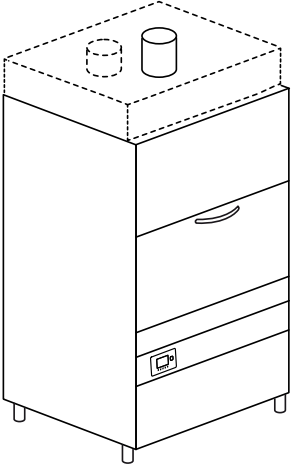

FEATURES

- The washing system is covered by an International Dual Patent
- Twelve wash cycles, six of which combine water detergent and granules
- Soft-touch panel with multicolour key
- Functional LCD Display for a constant control of all operations
- Multi language control panel
- Double-wall body, fully insulated with high performance thermo-acoustic material
- AISI 316 body and impeller, high performance wash-pump
- Wash-tank in AISI 304 S/S with guaranteed homogeneous thickness
- Double, vertical easy-fit wash-arms, with concave nozzles to prevent clogs and to optimize the combined flow of water and granules
- All electric and electronic components are sheltered in a dedicated box, for easy access from the machine's front
- The round basket is placed on a rotating support stand, to optimise the mechanical action of the granules on the surfaces to wash
- Granules collection strainer, with right-level mark for granules
- The resistant lower part of the door becomes a perfect working surface, simplifying the load/unload operations
- The optional service trolley facilitates the loading/unloading of the machine, increasing the operation speed and, consequently, the machine's productivity
- Heat recovery unit, to optimize energy resources and cut down on steam and wamodule

GRANULES

GRANULES
WAREWASHER

Model	Voltage	Capacity	Dimensions	Code
GRANULES 900 PLUS	12 PROGRAMS			
	400 V 3N ~ 50 Hz 13 kW	6xGN 1/1 (cycle with granules) 10xGN 1/1 (cycle w/o granules)		
		 530x325xmax65 H	1095x910 1910/2020 H 303 kg	GRANULES 900 PLUS
		 650x530xmax140 H		
		 600x400x20 H  600x400x50 H	1095x910x2100 H 320 kg	GRANULES 900 HR PLUS
		 Ø30 max 50 H  Ø40 max 45 H  Ø50 max 35 H		

OPTIONS

Model	220-240 V 50 Hz	380-415 V 3N 50 Hz	220-240 V 3 50 Hz	380-415 V 3 50 Hz	60 Hz	XP Extra Power	PS Drain Pump	DBE Peristaltic Rinse-Aid Disp.
GRANULES 900 PLUS	----	●	□	€	€	€	----	●
GRANULES 900 HR PLUS	----	●	□	€	€	€	----	●
GRANULES 1000 HR PLUS	----	●	□	€	€	€	----	●

● Standard

---- Not available

□ Upon request

XP In case of cold water supply for rinse (8-55 °C) and without any heat recovery , the extra power option is mandatory. +3000 W with standard voltage only, for other voltages please contact us. In case of cold water supply for rinse (8-15 °C), we recommend the heat recovery option

Water supply 55 °C (except HR versions)

EAC label upon request

Compatibilità di ogni opzione da confermare previa verifica del produttore

Model	Voltage	Capacity	Dimensions	Code
GRANULES 1000 HR PLUS	12 PROGRAMS			
	400 V 3N ~ 50 Hz 13 kW	8xGN 1/1 530x325xmax65 H	1200x1010 2260/2305 H 350 kg	GRANULES 1000 HR PLUS
		4xGN 2/1 650x530xmax140 H		
		3XEN 800x600x20 H 800x600x50 H		
		 Ø30 max 60 H Ø40 max 60 H Ø50 max 50 H		

	DDE	PAP	BT	WRAS	DVGW	FLOAT	DWI	PI
Model	Detergent Dispenser	Booster Pump	Break Tank	Wras	DVGW	Probes lack det and rinse aid	Thermo-acoustic insulation	S/S Pumps
GRANULES 900 PLUS	€	●	●	€	€	€	●	●
GRANULES 900 HR PLUS	€	●	●	----	----	€	●	●
GRANULES 1000 HR PLUS	€	●	●	----	----	€	●	●

BT - WRAS - DVGW Booster pump included





DVGW Components prescribed by DVGW on request (check option compatibility with the manufacturer)

HR Heat recovery (in case of cold water supply 8-15 °C)
 The ENERGY RECOVERY SYSTEM uses the heat produced by the machine to preheat the infeed of cold rinse water supply (8-15 °C)
 Optimal air temperature in the dishwashing area thanks to the reduction of the steam and the humidity produced by the machine
 HR available in case of osmotic water supply if the electrical conductivity is higher than 200 microsiemens

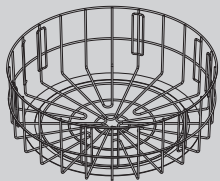
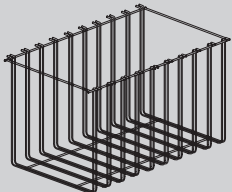
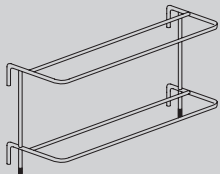
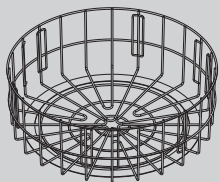
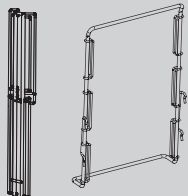
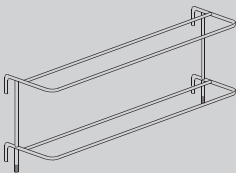
GRANULES

ACCESSORIES

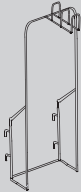
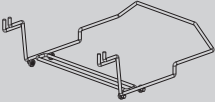
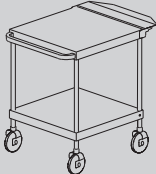
	Description		Dimensions	Code	
	ROUND BASKET	Std. equipment for GRANULES 900 PLUS 6 pz GN 1/1 or: 2 pz GN 2/1	Ø735 x 240 H	96101	
	STAND FOR TRAYS	Std. equipment for GRANULES 900 PLUS 10 pz GN 1/1 GASTRONORM max 40 mm		96135	
	STAND FOR TINS	Std. equipment for GRANULES 900 PLUS 4 pz 600x400x20 H or: 4 pz 600x400x50 H EURONORM		96136	
	ROUND BASKET	Std. equipment for GRANULES 1000HR PLUS 8 pz GN 1/1 or: 4 pz GN 2/1	Ø850 x 350 H	96601	
	HOLDER	Std. equipment for GRANULES 1000HR PLUS	4 pcs (96602) GN 1/1, 2/1	96602	
			1 pcs (96604) GN 1/1, 2/3, 1/2, 1/3	96604	
	STAND FOR TINS	Std. equipment for GRANULES 1000HR PLUS 3 pz 800x600x20 H or: 3 pz 800x600x50 H EURONORM	600x600x900H 15 kg	96603	

	Description		Dimensions	Code	
	HOLDER	Standard equipment for GRANULES 900 PLUS GRANULES 1000 HR PLUS Stand for 96103 and pots stand		96102	
	BASKET	Standard equipment for GRANULES 900 PLUS GRANULES 1000 HR PLUS Spatulas basket		96103	
	HOLDER	Standard equipment for GRANULES 900 PLUS GRANULES 1000 HR PLUS Stand for small pots and frying pans		96104	
	HOLDER	Standard equipment for GRANULES 900 PLUS GRANULES 1000 HR PLUS Stand for big pots		96105	
	BASKET LIFTER	Standard equipment for GRANULES 900 PLUS GRANULES 1000 HR PLUS Trolley to easily lift the basket		96605	
	SERVICE TROLLEY	Option for GRANULES 900 PLUS GRANULES 1000 HR PLUS	600x600x900H 15 kg	TROLLEY	
	GRANULES	Standard equipment for GRANULES 900 PLUS GRANULES 1000 HR PLUS Bucket 12 l	280x280x290H (9 kg)	96100	











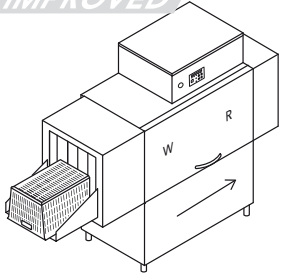

VX models are conceived to wash a large quantity of crates and containers of any kind. They represent the ideal solution for bakeries, pastries and for the general food industry, which require a seamless flow of clean containers. Thanks to all available versions and to the possibility to get personalized configurations, any kind of dirt can be removed. Several options are available, to provide the best fit into the wash area and minimize the need of efforts and labor.

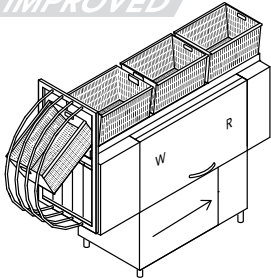
The VX line is designed to provide, mainly in the bakery sector, stunning results at low running costs, allowing remarkable savings under each aspect of its usage. The range is composed of 9 models, all suitable for the general food-industry who needs to wash and sanitize a large number of crates every day. Versatility is one of the most prominent advantages of this line, combined with easy operations and absolute cleanness, according to the strictest hygiene prescriptions.

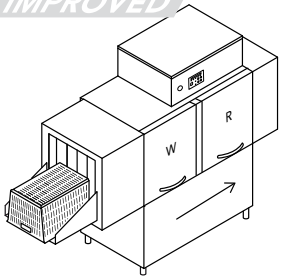

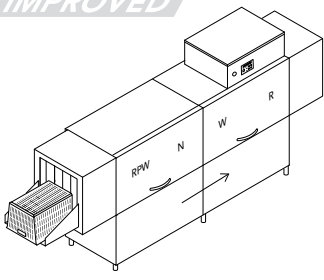
FEATURES

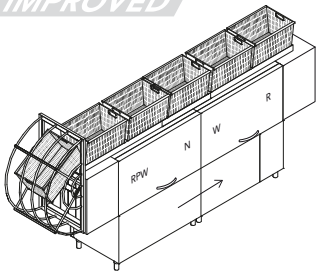
- Electrical or steam-heated VX 231, VX 301 and VX 401
- Middle-rail system, perfect to wash crates of any width. In addition, our VX 231 SPECIAL, VX 301 SPECIAL and VX 401 SPECIAL models are equipped with an innovative top-down loading system allowing a "one-person-only" operation
- **NEW:** five operating speeds
- Double-wall body in stainless steel AISI 304
- ACID PROOF radial wash tanks and boilers in s/s AISI 316; fully insulated boilers to minimize thermal loss
- Self-cleaning vertical wash pumps, protected from electrical overloads
- Double-skin doors with THERMO BARRIER device, insulated and counterbalanced, equipped with anti-fall safety device.
- CLEAN+ surface filters in stainless steel
- Easily removable wash and rinse arms in stainless steel
- S/S adjustable feet
- Inlet chute and splash-guard modules at both ends
- Anti-contamination curtains
- Consumptions economizers
- Electronic panel with IPX5 membrane keyboard, ensuring a constant monitoring of operating parameters
- Autotimer, switching off the rack conveyor motor and all electrical devices after a pre-set lapse of inactivity
- Centralized drain 1-DRAIN for VX 231 and VX 281 models

Model	Voltage	Capacity	Dimensions	Code
VX 231 5 SPEEDS				
IMPROVED 	400 V 3N ~ 50 Hz 30 kW	 510x500 H	2600x805x1830/2120 H 270 kg	VX 231
	400 V 3N ~ 50 Hz 2,4 kW 45 kg/h	1,5-2,0 m/min		VX 231 V
VX 231 SPECIAL 5 SPEEDS - Upper loading system				
IMPROVED 	400 V 3N ~ 50 Hz 30 kW	 510x500 H	2710x805x2075/2120 H 280 kg	VX 231 SPECIAL
		1,5-2,0 m/min		
VX 281 5 SPEEDS				
IMPROVED 	400 V 3N ~ 50 Hz 33 kW	 510x800 H	2800x805x2130/2720 H 310 kg	VX 281
		1,5-2,0 m/min		
VX 301 - VX 401 5 SPEEDS				
IMPROVED 	400 V 3N ~ 50 Hz 37 kW 3,7 kW - 54 kg/h	 510x500 H	4100x805x1830/2120 H 455 kg	VX 301
	400 V 3N ~ 50 Hz 41 kW 4,6 kW - 59 kg/h	2,0-2,6 m/min (VX 301)		VX 301 V
		2,6-4,0 m/min (VX 401)		VX 401
				VX 401 V
VX 301 SPECIAL - VX 401 SPECIAL 5 SPEEDS - Upper loading system				
IMPROVED 	400 V 3N ~ 50 Hz 37 kW	 510x500 H	4210x805x2075/2120 H 505 kg	VX 301 SPECIAL
	400 V 3N ~ 50 Hz 41 kW	2,0-2,6 m/min (VX 301)		VX 401 SPECIAL
		2,6-4,0 m/min (VX 401)		

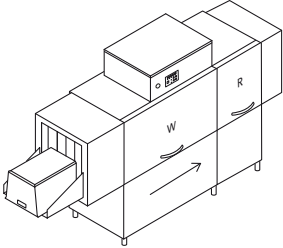
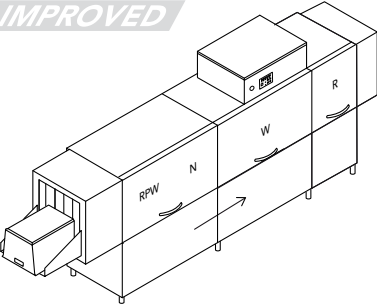
Model	Voltage	Capacity	Dimensions	Code	Code
VX 251	5 SPEEDS - For non-perforated crates				
IMPROVED					
	400 V 3N ~ 50 Hz 30 kW	510x500 H 1,5-2,0 m/min	3200x805x1830/2120 H 270 kg	VX 251	
VX 351	5 SPEEDS - For non-perforated crates				
IMPROVED					
	400 V 3N ~ 50 Hz 37 kW	510x500 H 2,0-2,6 m/min	4700x805x1830/2120 H 455 kg	VX 351	

- W** Wash
- R** Rinse
- N** Neutral zone
- RPW** Reinforced prewash
- V** Steam heated

EAC label upon request

Option compatibility to be confirmed by the manufacturer after verification

	H max	min < L1 < max	min < L2 < max	Depth max
VX 231 - VX 301 - VX 401	500	400 < L1 < 510	400* < L2 < 510	600
VX 301 - VX 401 + DRYER	500	400 < L1 < 510	400* < L2 < 510	600
VX 281	800	400 < L1 < 510	400* < L2 < 510	600
VX 231 SPECIAL - VX 301 SPECIAL - VX 401 SPECIAL	500	400 < L1 < 470	400* < L2 < 510	600
VX 251 - VX 351	500	400 < L1 < 510	400* < L2 < 510	600

* Verify with the manufacturer

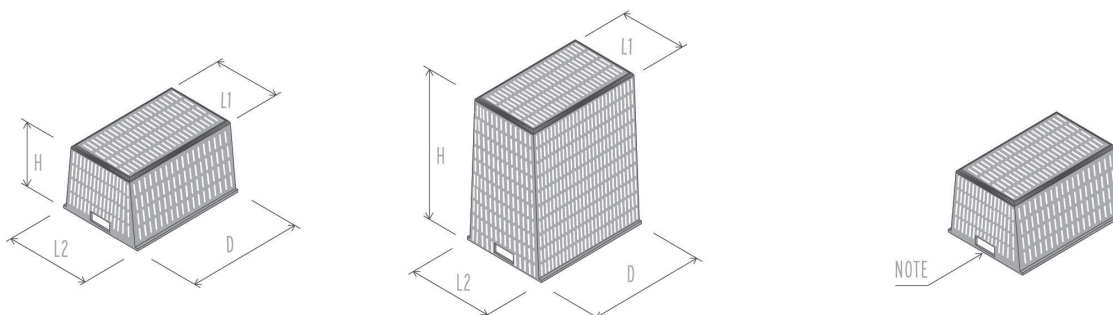

NOTE: Should you need to wash baskets with non-standard handles or dimensions, please contact our technical department

OPTIONS

			XP	DDE-GROUP	PI	DRIVE	AUTOTIMER
Model	220-240 V 3 50 Hz	60 Hz	Extra Power	Dispensers kit	S/S pumps	Smart drive	Autotimer
VX 231	€	+ 3%	€	€	€	€	●
VX 231 V	€	+ 3%	----	€	€	€	●
VX 231 SPECIAL	€	+ 3%	€	€	€	€	●
VX 281	€	+ 3%	€	€	€	€	●
VX 301	€	+ 3%	€	€	€	€	●
VX 301 V	€	+ 3%	----	€	€	€	●
VX 301 SPECIAL	€	+ 3%	€	€	€	€	●
VX 401	€	+ 3%	€	€	€	€	●
VX 401 V	€	+ 3%	----	€	€	€	●
VX 401 SPECIAL	€	+ 3%	€	€	€	€	●
VX 251	€	+ 3%	€	€	€	€	●
VX 351	€	+ 3%	€	€	€	€	●

● Standard

---- Not available

DDE-GROUP Both detergent (with probe) and rinse-aid dispensers included

PI Available with 50 Hz frequency only

DRIVE Check voltage compatibility

Warm water supply 55 °C

We recommend to install the machine in a well ventilated room, with a properly sized steam exhausting system

Option compatibility to be confirmed by the manufacturer after verification

	DOS/S	PAP	DIV	1-DRAIN	DWI	BT	DVGW
Model	Dispenser with probe	Booster pump	Price per division	Centralized drain	Thermoacoustic insulation	Break Tank	DVGW
VX 231	€	€	€	●	€	€	€
VX 231 V	€	€	€	●	€	€	€
VX 231 SPECIAL	€	€	€	●	€	€	€
VX 281	€	€	€	●	€	€	€
VX 301	€	€	€	€	€	€	€
VX 301 V	€	€	€	€	€	€	€
VX 301 SPECIAL	€	€	€	€	€	€	€
VX 401	€	€	€	€	€	€	€
VX 401 V	€	€	€	€	€	€	€
VX 401 SPECIAL	€	€	€	€	€	€	€
VX 251	€	€	€	●	€	€	€
VX 351	€	€	€	€	€	€	€

DOS/S For detergent dispenser only

DWI Insulation option for the tunnel only, dryer excluded. Recommended with HR10 – HR20 – HRP40

BT Booster pump included

DVGW Not available with heat recovery and steam condenser
Components prescribed by DVGW on request (check option compatibility with the manufacturer)

SPECIAL Upper sliding support for crates with maximum width 475 mm

OPTIONS

	DR94	DR99	DR9V	TB94	TB99	TB9V
Model	Dryer + 700 mm / 4,5 kW	Dryer + 700 mm / 9 kW	Steam dryer + 700 mm	Dryer on module with blowers	Dryer on module with blowers	Steam dryer on module with blowers
VX 231	€	€	----	€	€	----
VX 231 V	----	----	€	----	----	€
VX 231 SPECIAL	----	----	----	----	----	----
VX 281	----	----	----	----	----	----
VX 301	€	€	----	€	€	----
VX 301 V	----	----	€	----	----	€
VX 301 SPECIAL	----	----	----	----	----	----
VX 401	€	€	----	€	€	----
VX 401 V	----	----	€	----	----	€
VX 401 SPECIAL	----	----	----	----	----	----
VX 251	€	€	----	€	€	----
VX 351	€	€	----	€	€	----

- Standard
- Not available

ALL DRYERS Ask the producer for effectiveness on drying results according to the basket to wash. The insulation of the dryers is not available

DR94 With VX 301, VX 401 and VX 351 HD, optional not ideal, verify with manufacturer

With osmotic water supply and electrical conductivity lower than 200 microsiemens, it is mandatory to install a stainless steel heat exchanger

Option compatibility to be confirmed by the manufacturer after verification

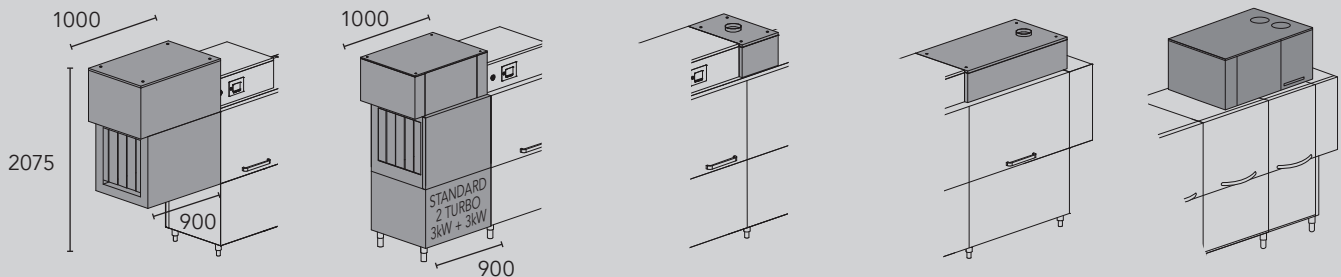

DR94 4,5 kW	TB94 11,6 kW	SC10	HR20	HRP40
DR99 9 kW	TB99 16,1 kW	Steam condenser	Heat recovery	Heat recovery with heat pump
Dryer	Dryer on module with blowers	HR10		
		Compact heat recovery		
DR9V	TB9V 7,1 kW			
Steam-heated dryer	Steam-heated dryer on module with blowers			

	DR54	DR59	SC10	HR10	HR20	HRP40
Model	Dryer 4,5 kW	Dryer 9 kW	Steam Condenser	Heat Recovery	Heat Recovery	Heat Recovery
VX 231	----	----	€	€	----	----
VX 231 V	----	----	€	€	----	----
VX 231 SPECIAL	----	----	----	----	----	----
VX 281	€	€	€	€	----	----
VX 301	----	----	€	€	€	€
VX 301 V	----	----	€	€	€	€
VX 301 SPECIAL	----	----	----	----	----	----
VX 401	----	----	€	€	€	€
VX 401 V	----	----	€	€	€	€
VX 401 SPECIAL	----	----	----	----	----	----
VX 251	----	----	€	€	----	----
VX 351	----	----	€	€	€	€

HR10 - HR20 - HRP40 In case of cold water supply for rinse (8-15 °C), we recommend to install the heat recovery system option

XP In case of cold water supply for rinse (8-55 °C) and without any heat recovery, the extra power option is mandatory. In case of cold water supply for rinse (8-15 °C), we recommend the heat recovery option.

We strongly recommend the presence of a roller table with end microswitch at the exit of our rack conveyor machines for a correct operation

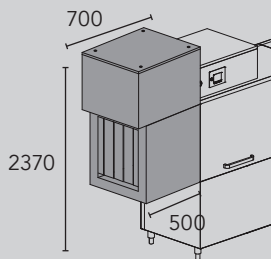

DR54 4,5 kW

DR59 9 kW

Dryer

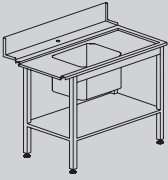
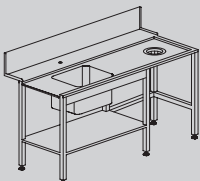
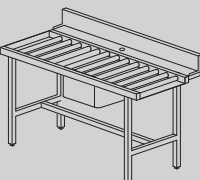
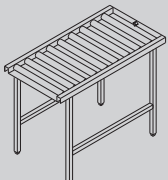
	Description		Dimensions	Code
	TABLE + SINK	Sink 500x400x270 H	1200x730x860 H	T 55
	TABLE + SINK	Sink 500x400x270 H Standard rubber ring	1500x730x860 H 1800x730x860 H	T 80 T 90
	ROLLER TABLE + SINK right or left version	Sink 500x400x270 H	1600x730x860 H	T 195
	LINEAR ROLLER TABLE WITH TANK	Option end microswitch	1100x650x860 H 1600x650x860 H 2100x650x860 H	LC 96/A* LC 96/B* LC 96/C* LC 95

* Wooden cage +2% minimum + €

Special dimensions for tables upon request

We strongly recommend the presence of a roller table with end microswitch at the exit of our pull-through crate washers for a correct operation



DIHR conveyor crate-washers are the perfect answer for all those sectors in the food industry dealing with heavy workloads on a daily basis: large bakeries and pastry shops, meat or fish industry, catering services, commercial kitchens, airport facilities.

Our LX and LX-HD lines have been designed to offer our clients a comprehensive solution, tailored to their needs and work habits.

Our conveyor crate-washers line offers the possibility to choose among six highly customizable models, which however maintain some of the distinctive features of the DIHR brand, such as the usable belt width of 640 mm, usable height of 450 mm and a constant monitoring of operation temperatures and wash results.

All this while preserving limited dimensions, lower than the market average at an equal production capacity: with LX and LX-HD machines it is possible to wash even big or non-standard baskets, thanks to the addition of dedicated neutral zones between modules. Optimal wash results are always DIHR's main goal. What else to say, other than just try our LX and LX-HD models?

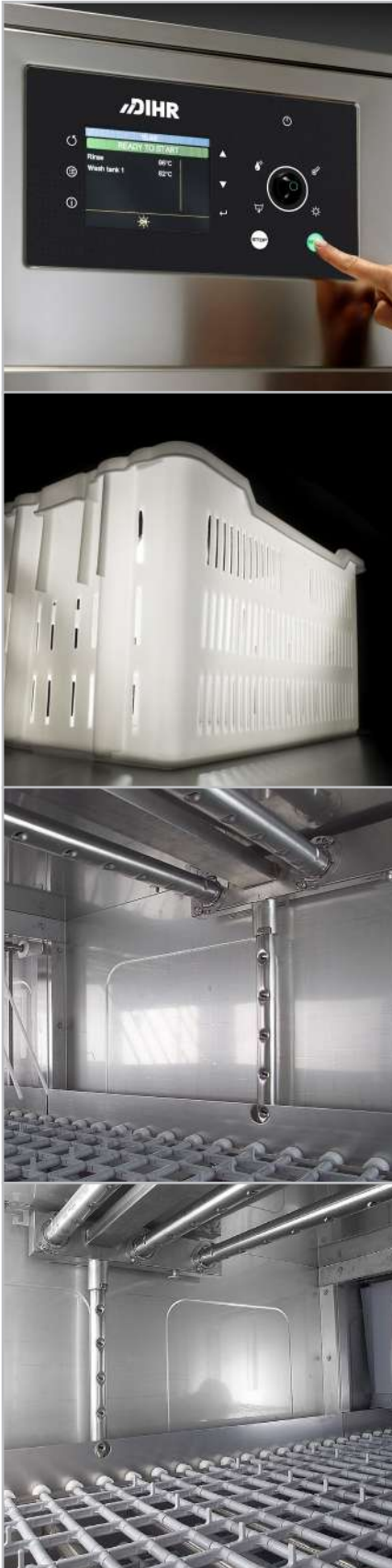

FEATURES

STANDARD

- SMART DRIVE 5-speed advancement system
- 710 mm wide conveyor with usable width of 640 mm
- Standard crates belt
- TFT 5.7" display and soft touch keyboard
- Frequently used keys shortcut and menu language setting
- Constant monitoring of key operations
- IPX5 electronic board
- Alarms and events report
- Autotimer
- Centralized 1-DRAIN and automatic AD drain, with total or partial emptying of the tanks
- Independent and adjustable wash arms
- Use economizers
- ECO-DET Detergent economizer
- ACID PROOF Radial wash tanks in AISI 316 stainless steel inclined to provide complete drainage of the wash water
- ACID PROOF stainless steel boilers in AISI 316, fully insulated to reduce thermal loss
- S/S surface filters CLEAN+ to protect the wash tanks as well as the wash pump
- Double-skin, insulated and counterbalanced doors, equipped with anti drop safety system
- THERMO BARRIER system for comfort in use
- Predisposition for DIHR rinse-aid and detergent dispensers connection
- Vertical self-cleaning pumps
- Reinforced double rinse 2R+, improved efficiency with lower consumption
- CPF System: Controlled Pressure Flow
- Water, energy consumptions and working time control system
- Possible working modes for dryer unit: all off, only fan, half power 4,5 kW + fan, total power 9 kW + fan
- Peak-cut for dosing included
- Estimated consumption readout

THERMO BARRIER

Our state of the art doors offer three main advantages: improved insulation of the washing chamber to maintain a constant temperature, reduction of power consumptions for boiler heating elements, and a decrease of humid vapour dispersed in the environment.

ACID PROOF

Our machines benefit from maximum protection against aggressive cleaning agents and salty water, thanks to the special composition and quality of the steel used for construction, both outdoing market standards. AISI 316 steel is indeed mainly employed in specific conditions of temperature and chemicals concentrations.

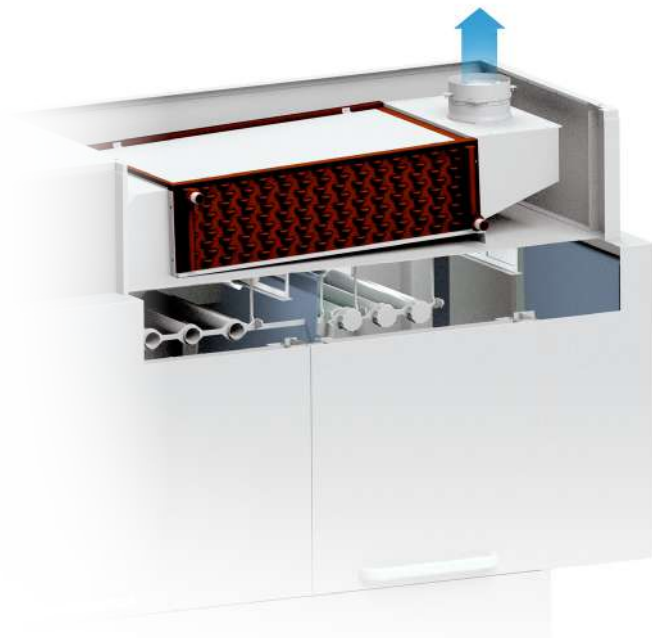

CLEAN+

The tank filtration system by DIHR ensures three protection modules: the first removing persistent dirt, the second on the overall tank to prevent water contamination and a third filter system to protect components.

CPF

This simple device allows to easily adjust water pressure in the prewash or wash phase in accordance to one's needs. By pulling the dedicated lever, it is possible to decrease water flow through nozzles of upper/lower wash arms.

OPTIONS

- Double belt or lower belt conveyor available
- Double skin shelf or dryer module
- Steam condenser
- 3 models of heat recovery to be chosen
- Dispensers kit with peristaltic pump, for detergent as well as rinse-aid
- Delivery in 2 or more parts, to ease installation operations
- Automatic self-cleaning of the machine available, with dedicated booster pump on request
- Thermal and acoustic insulation
- Tank insulation
- Heavy duty belt
- Break tank and booster pump
- Dedicated space for detergent and rinse-aid jugs
- S/S pumps
- Extra power in the boiler
- CONNECTIVITY remote control compliant with the HACCP norms

CONNECTIVITY 4.0 & APP

WHEREVER YOU ARE...

YOUR DISHWASHER, JUST A CLICK AWAY

You will be constantly connected to the machine to monitor the work phases, review any eventual alarm and configure remotely the operating parameters according to your needs. Compliant with HACCP norms. Thanks to our brand new App, you will have access to connected machines and all commercial and technical documentation.

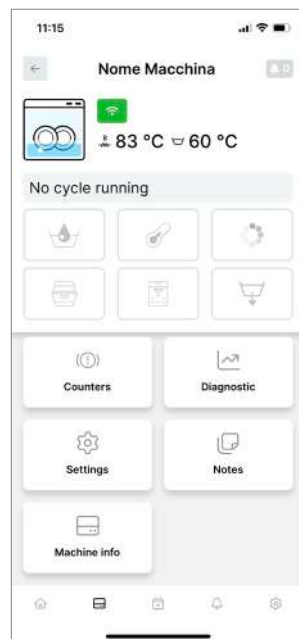

View all the working parameters and event records, working hours and any problem at any time.











In case of problem, the machine promptly alerts you. The technician can intervene remotely to solve the problem or anticipate the needed parts for an on-site intervention.

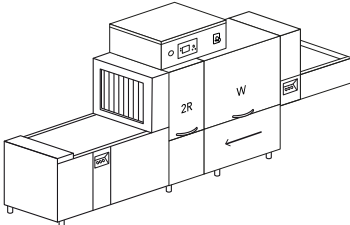

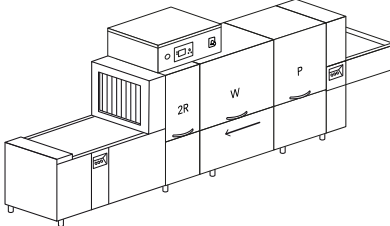
A daily activity report is available with all the events related to the dishwasher in a detailed spreadsheet with HACCP data.

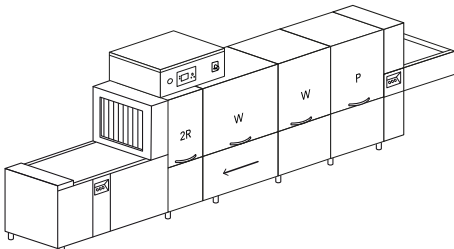

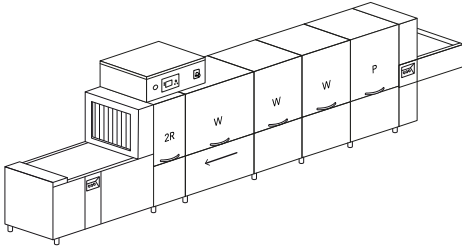
Our Connectivity system is a revolutionary device limiting and facilitating the eventual intervention of a technician who can anticipate the necessary parts to be replaced, saving time and money.

Model	Voltage	Capacity	Dimensions	Code
LX 501 5 SPEEDS				
	400 V 3N ~ 50 Hz 31,5 kW	 640x450 H belt width — 710 —	4900x985x1860/2200 H 625 kg	LX 501
	400 V 3N ~ 50 Hz 2,5 kW 48 kg/h	usable width — 640 — 2,20-3,45 m/min		LX 501 V
LX 751 5 SPEEDS				
	400 V 3N ~ 50 Hz 36,5 kW	 640x450 H belt width — 710 —	5800x985x1860/2200 H 775 kg	LX 751
	400 V 3N ~ 50 Hz 4,5 kW 52 kg/h	usable width — 640 — 3,25-5,10 m/min		LX 751 V
LX 1001 5 SPEEDS				
	400 V 3N ~ 50 Hz 56,5 kW	 640x450 H belt width — 710 —	6700x985x1860/2200 H 925 kg	LX 1001
	400 V 3N ~ 50 Hz 6,5 kW 82 kg/h	usable width — 640 — 4,45-6,95 m/min		LX 1001 V
LX 1251 5 SPEEDS				
	400 V 3N ~ 50 Hz 74,5 kW	 640x450 H belt width — 710 —	7600x985x1860/2200 H 1075 kg	LX 1251
	400 V 3N ~ 50 Hz 8,5 kW 108 kg/h	usable width — 640 — 5,27-8,23 m/min		LX 1251 V

Model	Voltage	Capacity	Dimensions	Code
LX 851 HD 5 SPEEDS				
	400 V 3N ~ 50 Hz 34,92 kW	 640x450 H belt width 710	6200x985x1860/2200 H 790 kg	LX 851 HD
	400 V 3N ~ 50 Hz 4,42 kW 50 kg/h	usable width 640 1,4-2,15 m/min		LX 851 HD V
LX 1101 HD 5 SPEEDS				
	400 V 3N ~ 50 Hz 52,42 kW	 640x450 H belt width 710	7500x985x1860/2200 H 1050 kg	LX 1101 HD
	400 V 3N ~ 50 Hz 6,42 kW 76 kg/h	usable width 640 1,95-3 m/min		LX 1101 HD V

- P** Prewash
- W** Power wash
- 2R** Pre-rinse + rinse on module
- V** Steam-heated

Option compatibility to be confirmed by the manufacturer after verification

OPTIONS

Model				PRE DOS	DDE-GROUP	DOS/S	SAN	PAP-SAN	DWI
	220-240 V 3 50 Hz	380-415 V 3N 50 Hz	60 Hz	DIHR disp. connections	Dispensers kit	Dispenser with probe	Saniti- zation	Booster pump sanitization	Thermo-acou- stic insulation
LX 501	+ 2%	●	+ 3%	●	€	€	€	€	€
LX 501 V	+ 1%	●	+ 3%	●	€	€	€	€	€
LX 751	+ 2%	●	+ 3%	●	€	€	€	€	€
LX 751 V	+ 1%	●	+ 3%	●	€	€	€	€	€
LX 1001	+ 2%	●	+ 3%	●	€	€	€	●	€
LX 1001 V	+ 1%	●	+ 3%	●	€	€	€	●	€
LX 1251	+ 2%	●	+ 3%	●	€	€	€	●	€
LX 1251 V	+ 1%	●	+ 3%	●	€	€	€	●	€
LX 851 HD	+ 2%	●	+ 3%	●	€	€	€	€	€
LX 851 HD V	+ 1%	●	+ 3%	●	€	€	€	€	€
LX 1101 HD	+ 2%	●	+ 3%	●	€	€	€	●	€
LX 1101 HD V	+ 1%	●	+ 3%	●	€	€	€	●	€

- Standard
- Upon request
- DDE-GROUP** Both detergent (with probe) and rinse-aid dispensers included
- PAP-SAN** Standard pump for models LX 1001, LX 1251 and LX 1101 HD
- DIV** Compulsory for machines > 4,5 m length
- BT** Booster pump included
- CONNECTIVITY** Includes HACCP option. 10-year plan
- DWI** Insulation option for the tunnel only, dryer excluded. Shelf dryer can be insulated upon request
- DWI-DWI/T** Recommended with HRF10 - HRF20 - HRPF40
- XP** In case of cold water supply for rinse (8-55 °C) and without any heat recovery, the extra power option is mandatory. In case of cold water supply for rinse (8-15 °C), we recommend the heat recovery option

EAC label upon request

Option compatibility to be confirmed by the manufacturer after verification

	DWI / T	CONNECTIVITY	XP	PAP	DRIVE	PI	1-DRAIN	ECO-DET	X-BELT	DIV	BT
Model	Tanks insulation	Connectivity (HACCP)	Extra power	Booster pump	Smart drive	S/S pumps	Centralized drain	Detergent saving system	Special belt	Price per division	Break tank
LX 501	€	€	€	€	●	€	●	●	+ 7%	€	€
LX 501 V	€	€	□	€	●	€	●	●	+ 7%	€	€
LX 751	€	€	€	€	●	€	●	●	+ 7%	€	€
LX 751 V	€	€	€	€	●	€	●	●	+ 7%	€	€
LX 1001	€	€	€	€	●	€	●	●	+ 7%	€	€
LX 1001 V	€	€	€	€	●	€	●	●	+ 7%	€	€
LX 1251	€	€	€	€	●	€	●	●	+ 7%	€	€
LX 1251 V	€	€	□	€	●	€	●	●	+ 7%	€	€
LX 851 HD	€	€	€	€	●	€	●	●	+ 7%	€	€
LX 851 HD V	€	€	€	€	●	€	●	●	+ 7%	€	€
LX 1101 HD	€	€	€	€	●	€	●	●	+ 7%	€	€
LX 1101 HD V	€	€	€	€	●	€	●	●	+ 7%	€	€

OPTIONS

	NZ3	NZ6	NZH6	DRF69	DRF6V	ID	DRF99M	DRF9VM	DRF99MB	DRF99MB1
Model	Neutral zone 300	Neutral zone 600	Neutral zone for dryer 600	Shelf dryer	Steam heated shelf dryer	Double skin for shelf dryer	Module dryer	Steam heated dryer module	Dryer module with blowers	Dryer module with blowers
LX 501	€	€	€	€	----	€	€	----	€	€
LX 501 V	€	€	€	€	€	€	€	€	€	€
LX 751	€	€	€	€	----	€	€	----	€	€
LX 751 V	€	€	€	€	€	€	€	€	€	€
LX 1001	€	€	€	€	----	€	€	----	€	€
LX 1001 V	€	€	€	€	€	€	€	€	€	€
LX 1251	€	€	€	€	----	€	€	----	€	€
LX 1251 V	€	€	€	€	€	€	€	€	€	€
LX 851 HD	€	€	€	€	----	€	€	----	€	€
LX 851 HD V	€	€	€	€	€	€	€	€	€	€
LX 1101 HD	€	€	€	€	----	€	€	----	€	€
LX 1101 HD V	€	€	€	€	€	€	€	€	€	€

---- Not available

NZ3 Recommended to wash long baskets

NZ6 Recommended to wash long baskets. Module equipped with a front door

NZH6 Recommended for dryers with blowers

U-AIR Proximity air nozzles available on every dryer module

ID Recommended option for DRF69 and DRF6V. Only for dryer on shelf

HD+BELT For each dryer module and neutral zone, the extra price is € .

With osmotic water supply and electrical conductivity lower than 200 microsiemens, it is mandatory to install a stainless steel heat exchanger

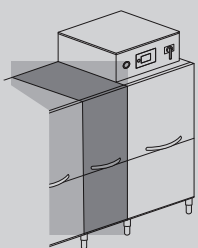

NZ3 + 300 mm
Neutral zone

NZ6 + 600 mm
Neutral zone
with door

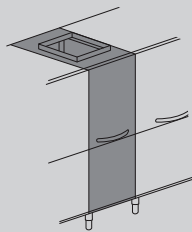

NZH6 + 600 mm
Neutral zone
with door
for dryer

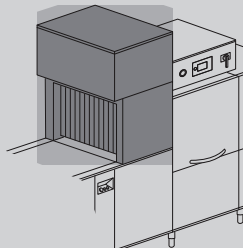

DRF69 9 kW
Shelf dryer

DRF6V
Steam-heated
shelf dryer

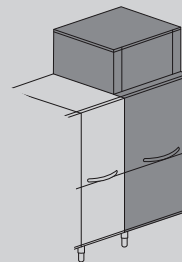

DRF99M + 900 mm - 9 kW
Dryer module

DRF9VM + 900 mm
Steam-heated
dryer module

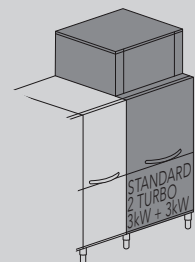

DRF99MB + 900 mm 16,1 kW
Dryer module

DRF9VMB + 900 mm 7,1 kW
Steam-heated
dryer module

Model	DRF99MB2 Dryer module with blowers	DRF9VMB Steam heated dryer module with blowers	DRF9VMB1 Steam heated dryer module with blowers	DRF9VMB2 Steam heated dryer module with blowers	U-AIR Proximity air nozzle	SCF10 Steam conden- ser	HRF10 Heat recovery	HRF20 Heat recovery	HRPF40 Heat recovery	3R Triple rinse	STOCK Chemicals com- partment	HD+BELT Heavy-duty belt
LX 501	€	----	----	----	€	€	€	----	€	€	€	€
LX 501 V	€	€	€	€	€	€	€	----	€	€	€	€
LX 751	€	----	----	----	€	€	€	€	€	€	€	€
LX 751 V	€	€	€	€	€	€	€	€	€	€	€	€
LX 1001	€	----	----	----	€	€	€	€	€	€	€	€
LX 1001 V	€	€	€	€	€	€	€	€	€	€	€	€
LX 1251	€	----	----	----	€	€	€	€	€	€	€	€
LX 1251 V	€		€	€	€	€	€	€	€	€	€	€
LX 851 HD	€	----	----	----	€	€	€	€	€	€	€	€
LX 851 HD V	€	€	€	€	€	€	€	€	€	€	€	€
LX 1101 HD	€	----	----	----	€	€	€	€	€	€	€	€
LX 1101 HD V	€	€	€	€	€	€	€	€	€	€	€	€

DRF99MB1 - DRF9VMB1 Lower by-pass belt with blowers. Maximum 1 per machine as an alternative to the double belt

DRF99MB2 - DRF9VMB2 Double belt with blowers. Maximum 1 per machine as an alternative to the lowered by-pass belt

HRF10 - HRF20 - HRPF40 In case of cold water supply for rinse (8-15 °C), we recommend to install the heat recovery system option

Option compatibility to be confirmed by the manufacturer after verification

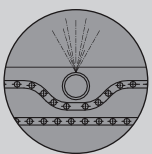

with blowers
and lowered belt

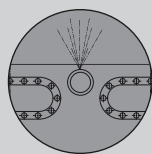

with blowers
and double belt

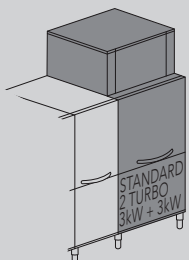

DRF99MB1 + 900 mm 16,1 kW
Dryer module

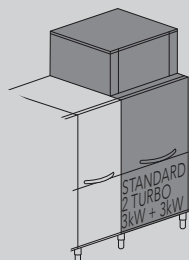

DRF99MB2 + 900 mm 16,1 kW
Dryer module

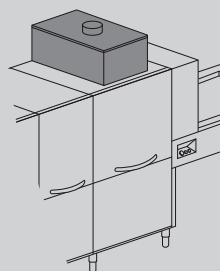

HRF10
Compact heat
recovery

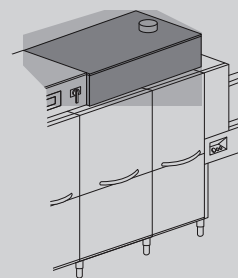

HRF20
Heat recovery

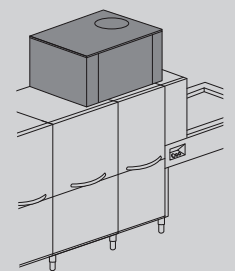

HRPF40
Heat recovery
with heat pump

DRF9VMB1 + 900 mm 7,1 kW
Steam-heated
dryer module

DRF9VMB2 + 900 mm 7,1 kW
Steam-heated
dryer module

SCF10
Steam condenser

OPTIONS

	MI900	MI1200	MIS1200	MI1500	MI1800	MI2200	MI2700
Model	Entry mod. 900	Entry mod. 1200	Over. entry mod. 1200	Entry mod. 1500	Entry mod. 1800	Entry mod. 2200	Entry mod. 2700
LX 501	€	€	●	€	€	€	€
LX 501 V	€	€	●	€	€	€	€
LX 751	€	€	●	€	€	€	€
LX 751 V	€	€	●	€	€	€	€
LX 1001	€	€	●	€	€	€	€
LX 1001 V	€	€	●	€	€	€	€
LX 1251	€	€	●	€	€	€	€
LX 1251 V	€	€	●	€	€	€	€
LX 851 HD	€	€	●	€	€	€	€
LX 851 HD V	€	€	●	€	€	€	€
LX 1101 HD	€	€	●	€	€	€	€
LX 1101 HD V	€	€	●	€	€	€	€

- Standard
- Upon request
- Not available

Option compatibility to be confirmed by the manufacturer after verification

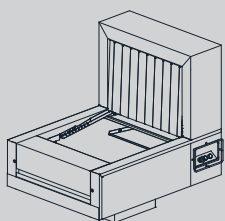

Overhanging entry module

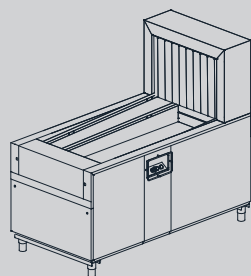

Entry module

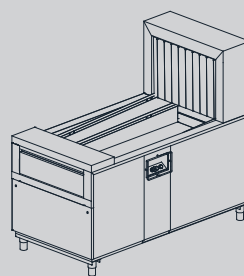

Exit module

	MIR2700	EM900	EM1200	EM1500	EM1800	EM2200	EM2700
Model	Lowered entry mod. 2700	Exit mod. 900	Exit mod. 1200	Exit mod. 1500	Exit mod. 1800	Exit mod. 2200	Exit mod. 2700
LX 501	€	□	□	□	●	€	€
LX 501 V	€	□	□	□	●	€	€
LX 751	€	□	□	□	●	€	€
LX 751 V	€	□	□	□	●	€	€
LX 1001	€	□	□	□	●	€	€
LX 1001 V	€	□	□	□	●	€	€
LX 1251	€	□	□	□	●	€	€
LX 1251 V	€	□	□	□	●	€	€
LX 851 HD	€	□	□	□	●	€	€
LX 851 HD V	€	□	□	□	●	€	€
LX 1101 HD	€	□	□	□	●	€	€
LX 1101 HD V	€	□	□	□	●	€	€

STANDARD SUPPLIED BASKETS

GLASSWASHERS	2 x glass baskets, 1 x saucer holder, 1 x cutlery holder
DISHWASHERS	1 x dish basket, 1 x glass basket, 1 x cutlery holder (ELECTRON 1000 PLUS + 1 C43)
HOOD-TYPE DISHWASHERS	2 x dish baskets, 1 x glass baskets, 2 x cutlery holders
RACK-TYPE DISHWASHERS	1 x dish basket, 1 x glass basket, 1 x cutlery basket 8 places, 1 x tray basket
WAREWASHERS	<p>LP1 S4 - LP1 400 PLUS: 1 x S/S trays support, 1 x large mesh plastic basket, 1 x spatula holder (LP1 S4 + 1 S/S griddle)</p> <p>LP1 S5 PLUS: 1 x S/S griddle, 1 x S/S basket, 1 x trays support, 1 x S/S spatula holder</p> <p>LP1 800 - LP1 S8 PLUS: 1 x S/S basket, 1 x S/S griddle, 1 x trays support, 1 x S/S spatula holder</p> <p>LP2 S PLUS - LP3 S PLUS - LP4 S8 PLUS: 1 x S/S basket, 1 x S/S trays support, 1 x S/S spatula holder</p>

DELIVERY	20 days for semi-automatic machines - 50 days for automatic machine
PACKING	Cardboard box (included in the price) The wooden cage's price is the equivalent of the 2% of the machine's net price -minimum amount charged is 85 € (on the following models: RX, QX, TX, TS, VX, LX, LX-HD, TC, RTC, LC77/2, LC77/3, LC96, LC97, LC97/2, LC97/3, A10, A20)
SPARE PARTS	For orders lower than net 50 €, a 5 € fee will be applied as management costs
TERMS	Ex-works
WARRANTY ON OUR PARTS	24 months from invoice date, subject to our technical department verification of the problem causes
TRANSPORT	The supply is carried out Ex works DIHR Ali Group Srl. The goods travel at the Purchaser's sole risk even when the carrier has been chosen and instructed by DIHR Ali Group Srl on behalf of the purchasing party
OWNERSHIP RESERVATION	The goods are the exclusive property of DIHR Ali Group Srl until the invoice is paid in full
COURT OF JURISDICTION	Contracts stipulated with DIHR Ali Group Srl are subject to Italian law. For any dispute that may arise from contracts with DIHR Ali Group Srl - including abroad contracts - the court of jurisdiction shall be that of Treviso
USER MANUALS	User Manuals are originally issued in a main E.U. language. When put into service, each machinery must be provided with an appropriate translation of the original Manual in the language(s) used in the Country where the appliance is installed accompanied by its original instructions, too. This translation is full care and responsibility of the Importer of the machinery in the end-user's region. In case of tunnel machines, the possibility to have our technician/s on site to assist in the assembly and start-up will be quoted separately.

Ensure adequate ventilation of the room according to the legislation in force in the country of installation and the relevant technical standards. For example, for European countries, please refer to the EN 16282-1 standard.

Continual improvements may supersede specifications.



* The WRAS Approved Product logo is a certification marks which is owned by WRAS Ltd. - WRAS Approved Type AA - air gap

The certification brands do not refer to all products. Our documentation includes certified and non-certified products.

The information required by the Article 33 (1) of Regulation (EC) 1907/2006 (REACH) and the related SCIP notifications are available on our website.

For more information, please contact the manufacturer.



DIHR ALI GROUP SRL

Via del Lavoro, 28
31033 Castelfranco Veneto (TV)
T: +39 0423 7344
F: +39 0423 720442
E: dihr@dihr.com

Service:

T: +39 0423 734548
E: service@dihr.com

www.dihr.com

Edition 05.2024

an Ali Group Company



The Spirit of Excellence